

- B3011 3分角鋁
- B3012 4分角鋁
- B3013 6分角鋁
- B3015 1.1/4英吋角鋁

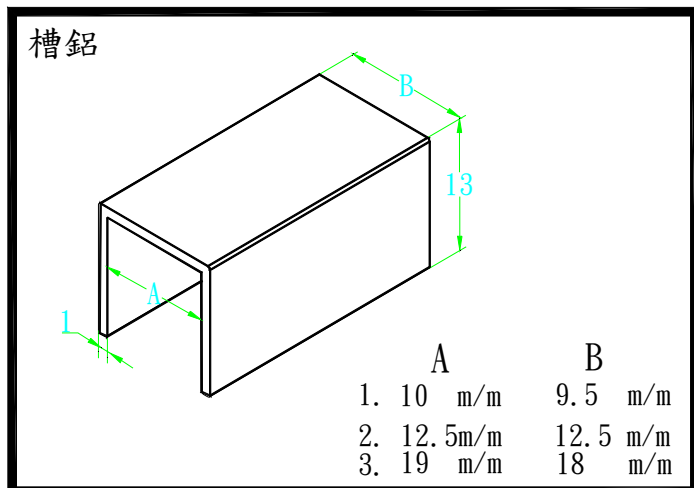

- B3031 3分槽鋁
- B3032 4分槽鋁
- B3033 6分槽鋁

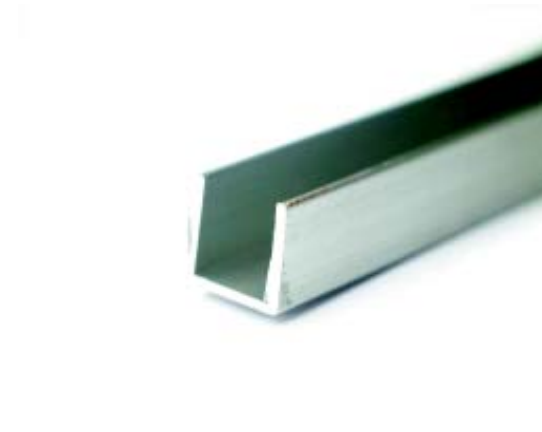
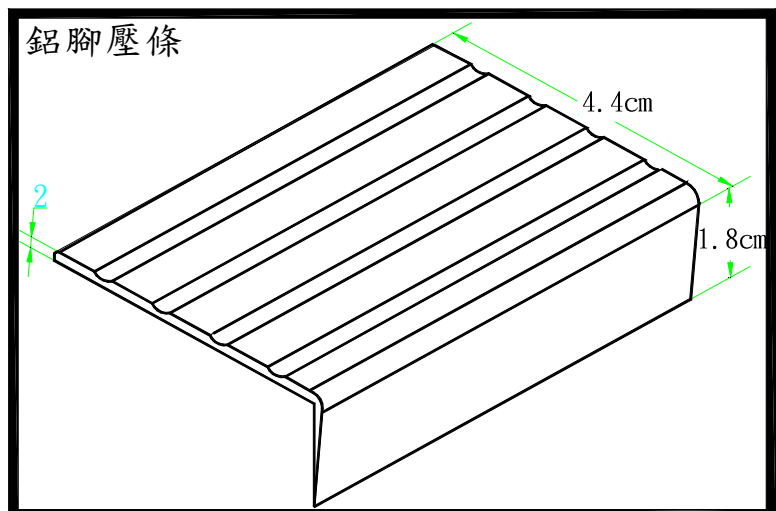
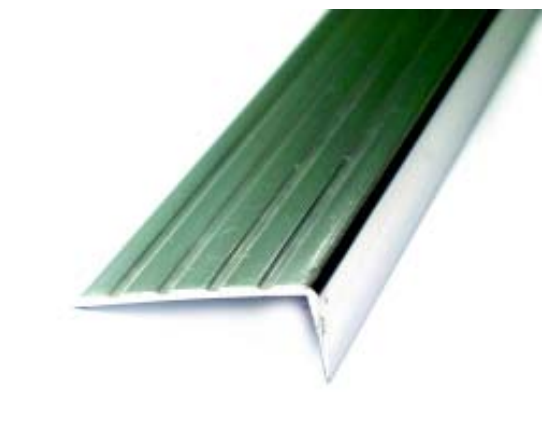

- B3051 鋁腳壓條薄鋁腳壓條 4.4x1.8x6M



B3063 T型角鋁 10mm\*10mm 6M  
B3064 T型角鋁 B 6.5MM\*6.5MM 6M

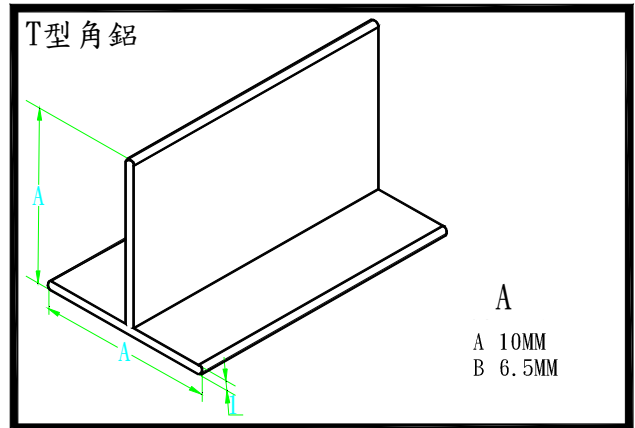

B3072 鋁壁板 5M

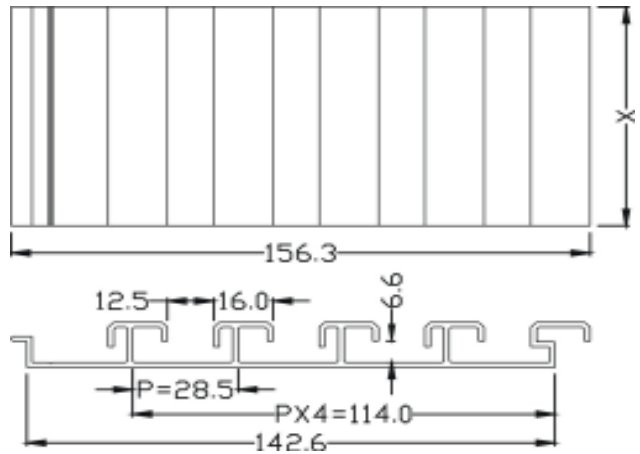

### 鋁壁板結構

如有過重或過長時，請塗上樹脂及AB膠，同時鎖上螺絲。

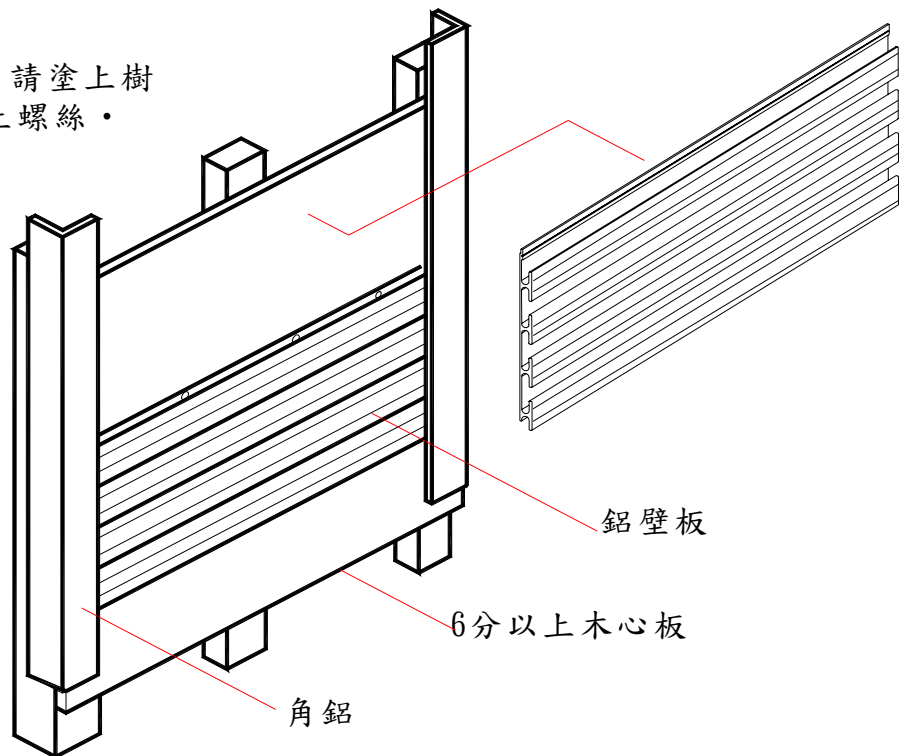



專利號碼：台灣 M242108  
日本 3099639  
中國 ZL03209647. X



B3076 專利展示塑膠壓修隔板

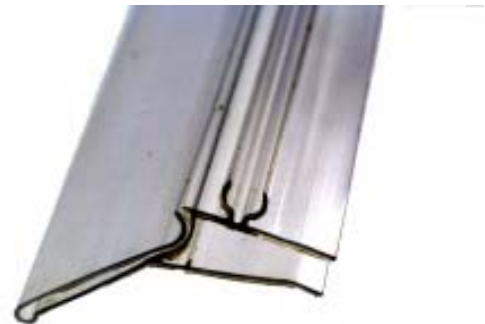

B3077 專利展示塑膠壓修隔板 - 壓條 8 尺  
B3078 專利展示塑膠壓修隔板 - 壓條 9 尺  
B3079 專利展示塑膠壓修隔板 - 壓條 12 尺



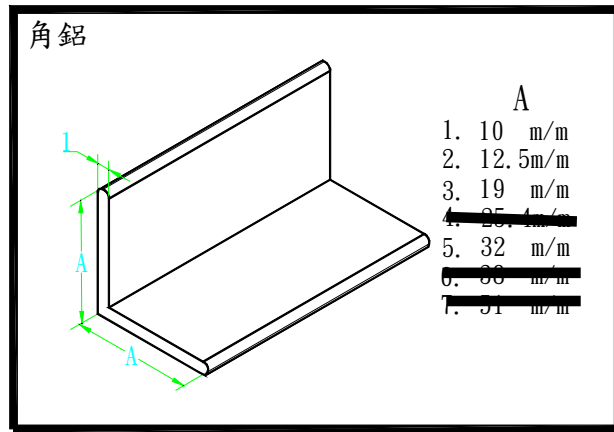
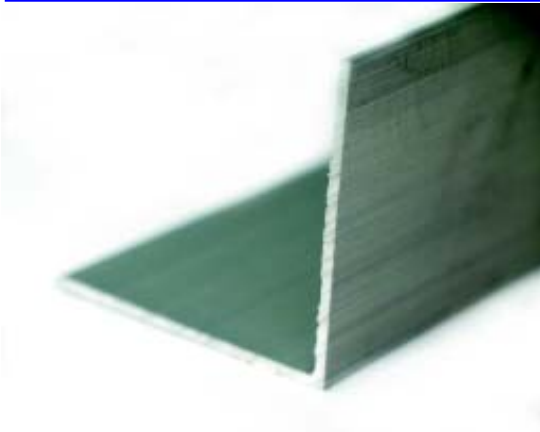

- B3011 3分角鋁
- B3012 4分角鋁
- B3013 6分角鋁
- B3015 1.1/4英吋角鋁

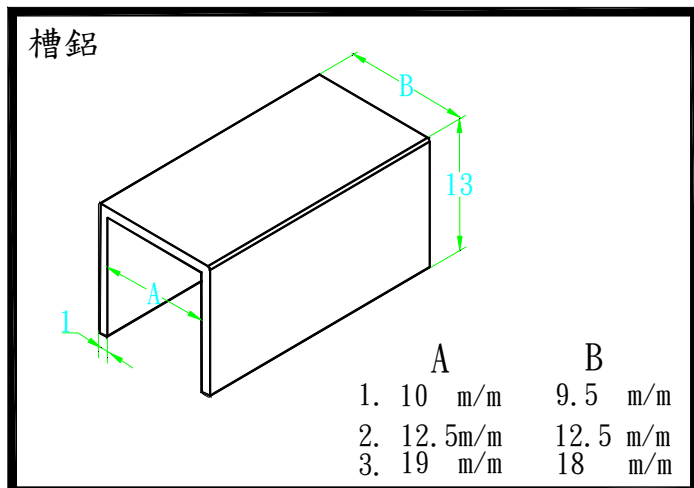
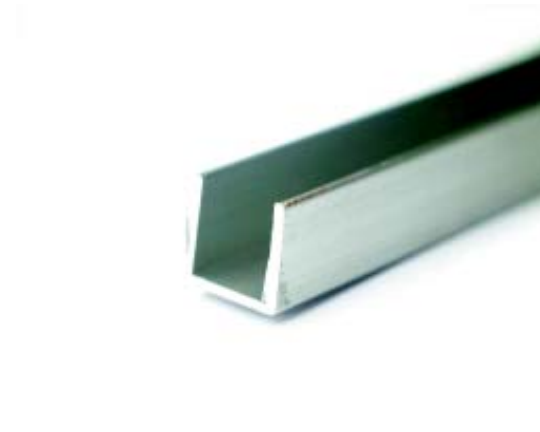

- B3031 3分槽鋁
- B3032 4分槽鋁
- B3033 6分槽鋁

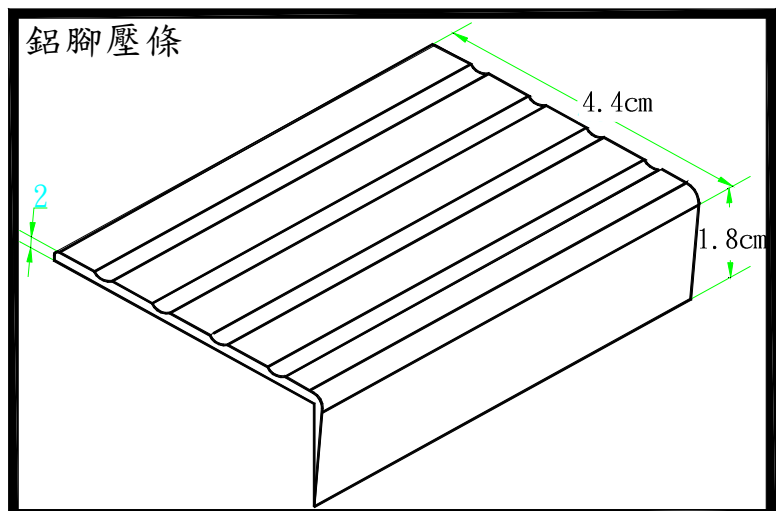
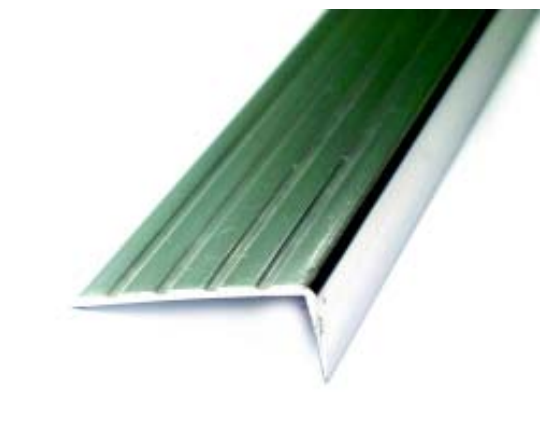

- B3051 鋁腳壓條薄鋁腳壓條 4.4x1.8x6M



B3063 T型角鋁 10mm\*10mm 6M  
B3064 T型角鋁 B 6.5MM\*6.5MM 6M

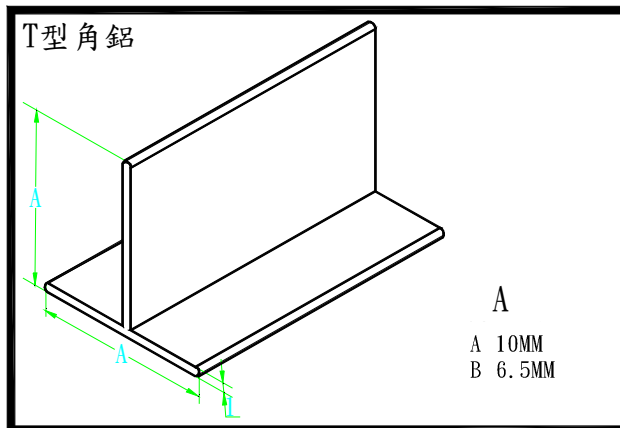

B3072 鋁壁板 5M

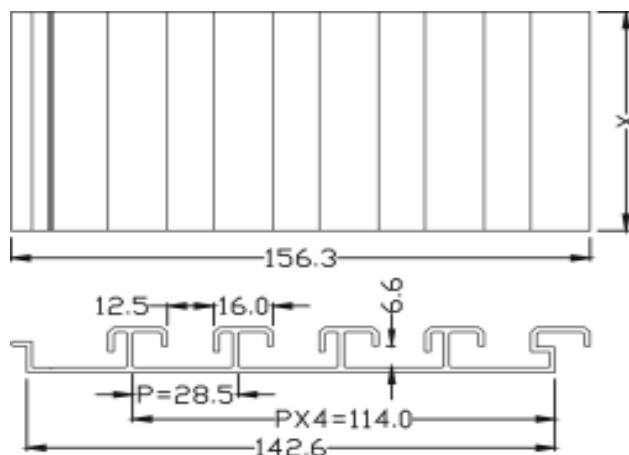

### 鋁壁板結構

如有過重或過長時，請塗上樹脂及AB膠，同時鎖上螺絲。

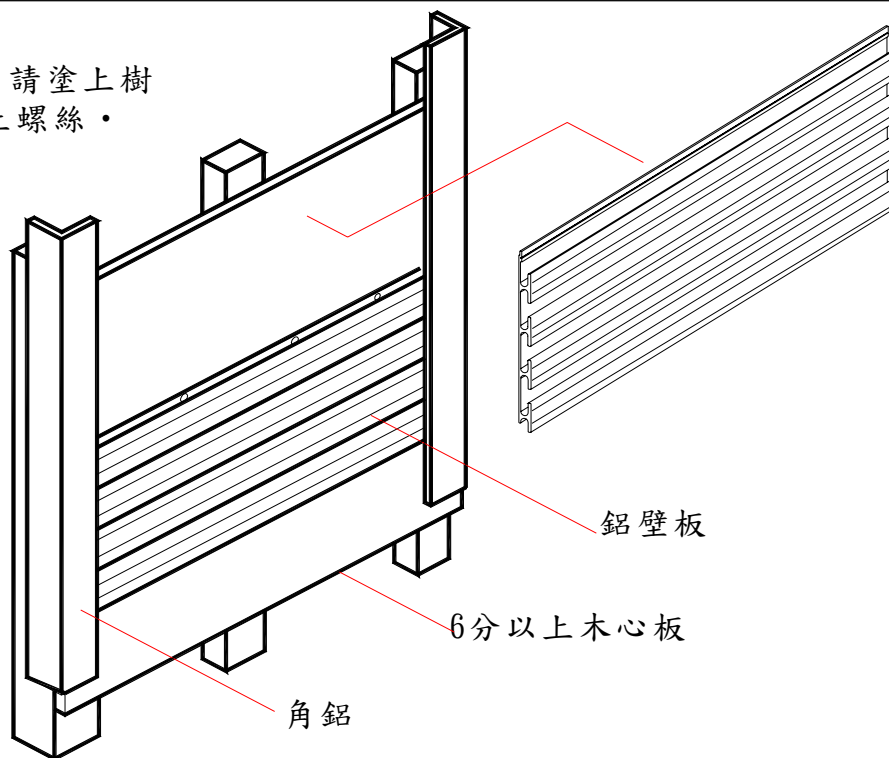



專利號碼：台灣 M242108  
日本 3099639  
中國 ZL03209647. X



B3076 專利展示塑膠壓修隔板

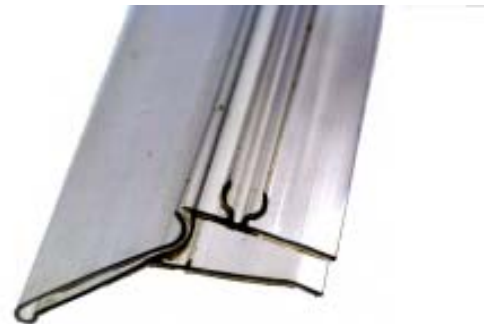

B3077 專利展示塑膠壓修隔板 - 壓條 8 尺  
B3078 專利展示塑膠壓修隔板 - 壓條 9 尺  
B3079 專利展示塑膠壓修隔板 - 壓條 12 尺





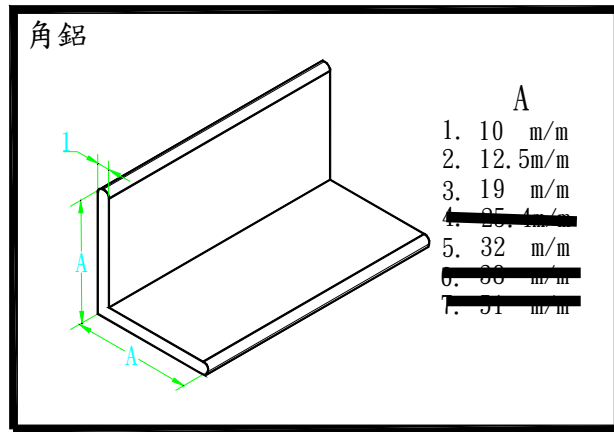
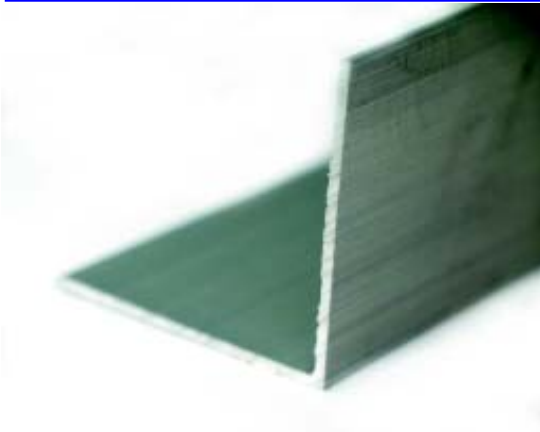

- B3011 3分角鋁
- B3012 4分角鋁
- B3013 6分角鋁
- B3015 1.1/4英吋角鋁

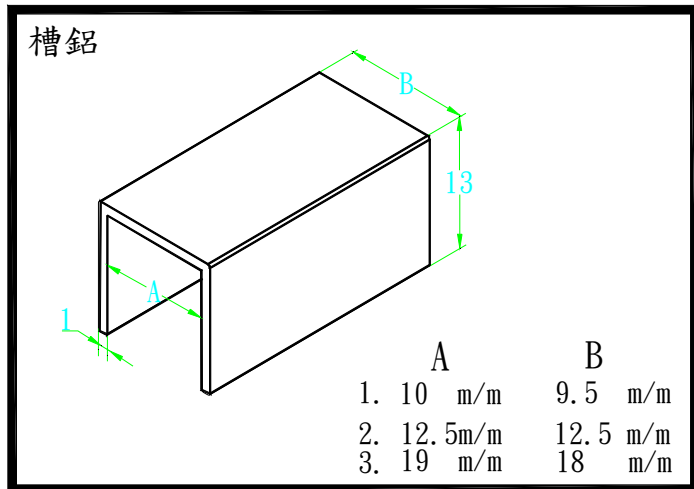
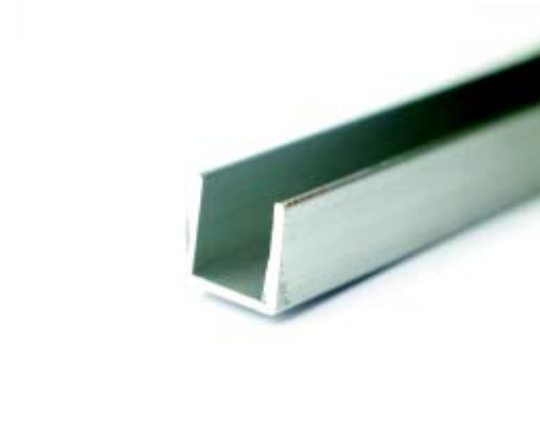

- B3031 3分槽鋁
- B3032 4分槽鋁
- B3033 6分槽鋁

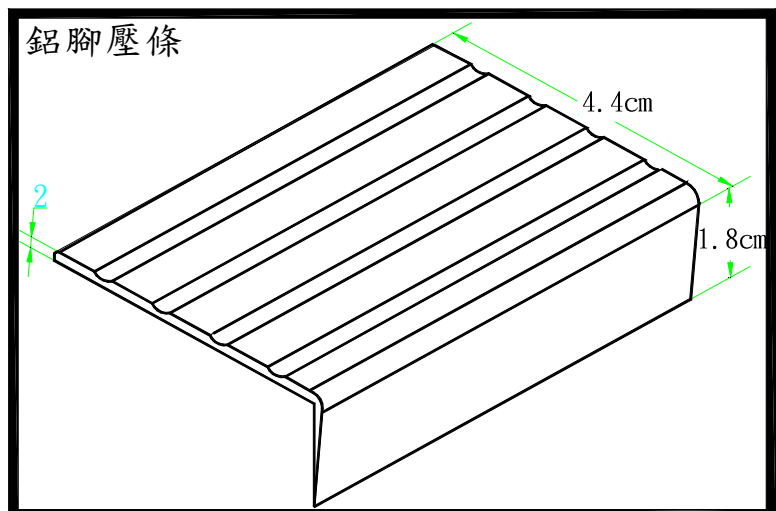
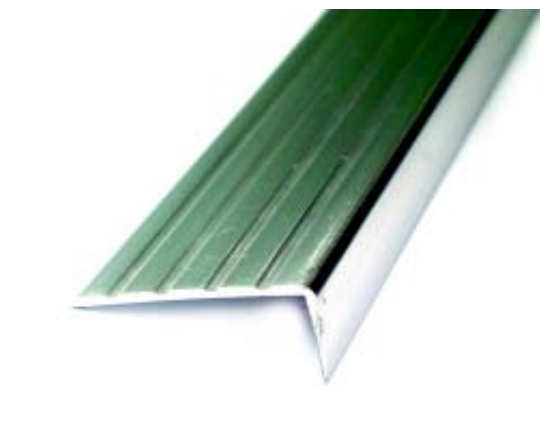

- B3051 鋁腳壓條薄鋁腳壓條 4.4x1.8x6M



B3063 T型角鋁 10mm\*10mm 6M  
B3064 T型角鋁 B 6.5MM\*6.5MM 6M

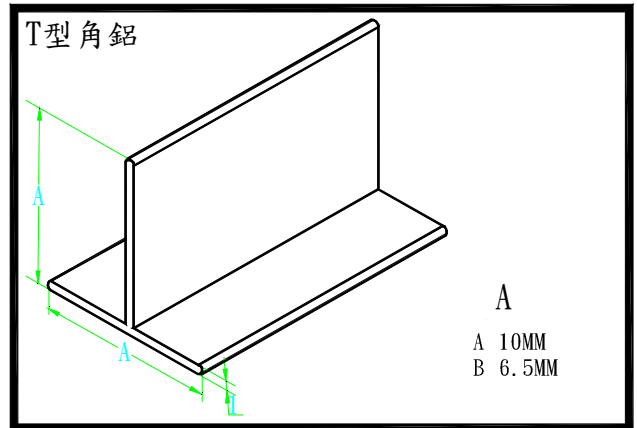

B3072 鋁壁板 5M

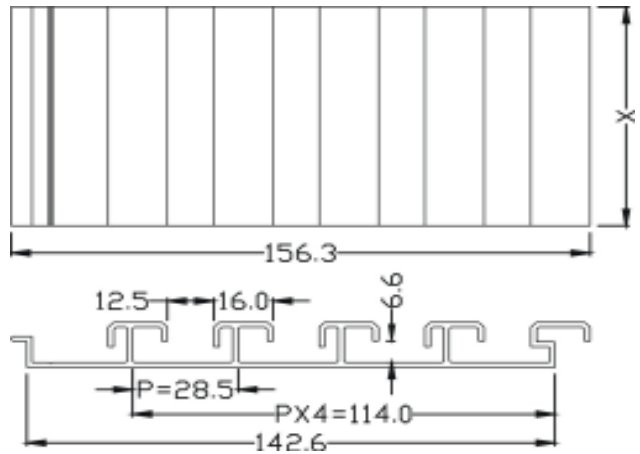

### 鋁壁板結構

如有過重或過長時，請塗上樹脂及AB膠，同時鎖上螺絲。

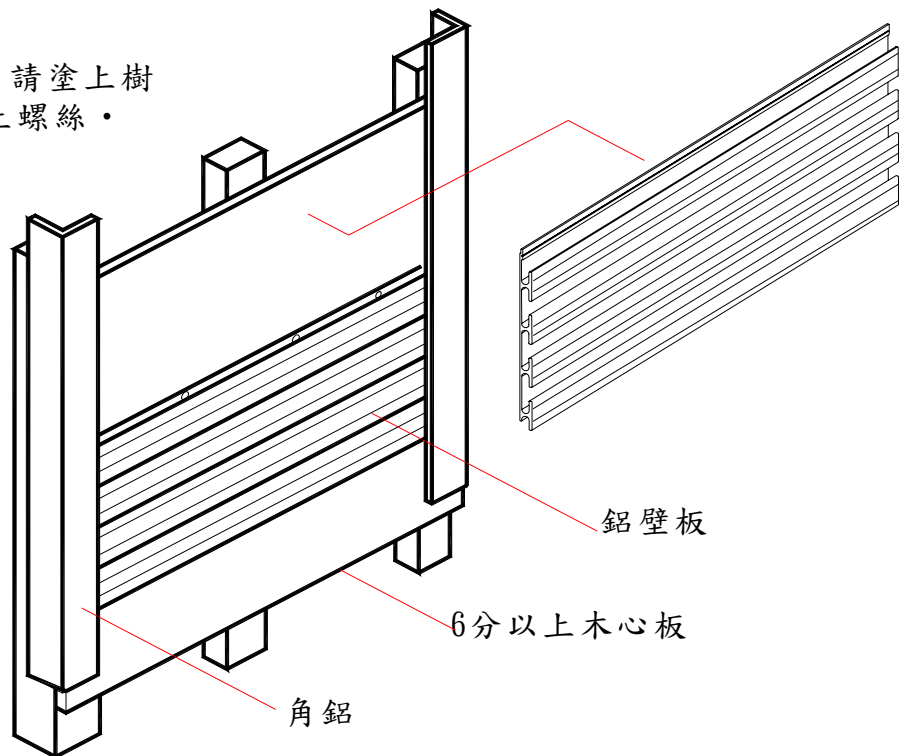



專利號碼：台灣 M242108  
日本 3099639  
中國 ZL03209647. X



B3076 專利展示塑膠壓修隔板

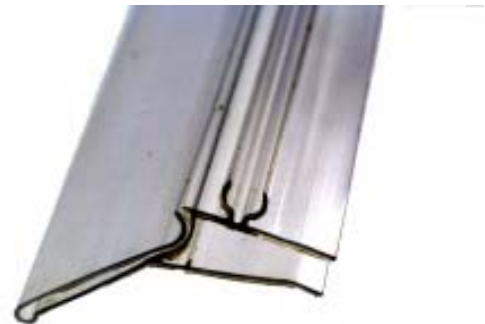

B3077 專利展示塑膠壓修隔板 - 壓條 8 尺  
B3078 專利展示塑膠壓修隔板 - 壓條 9 尺  
B3079 專利展示塑膠壓修隔板 - 壓條 12 尺



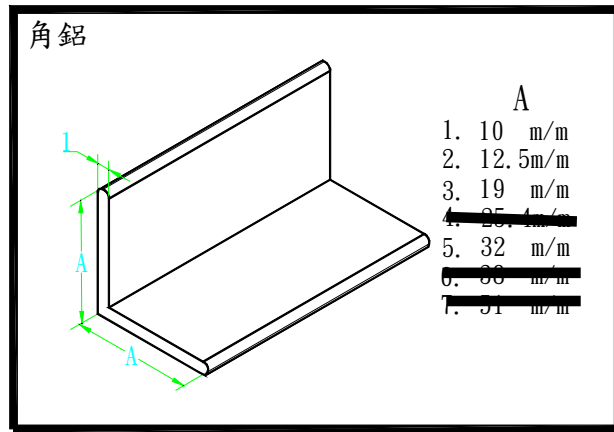
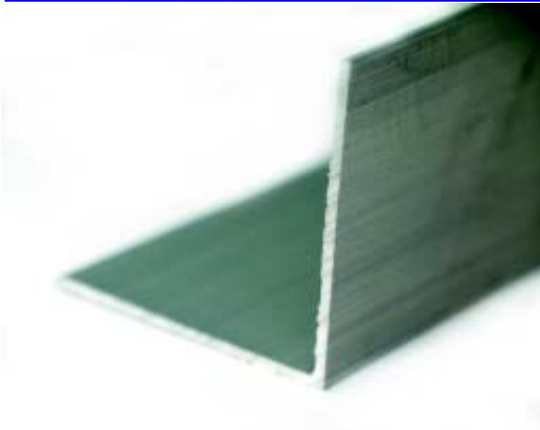

- B3011 3分角鋁
- B3012 4分角鋁
- B3013 6分角鋁
- B3015 1.1/4英吋角鋁

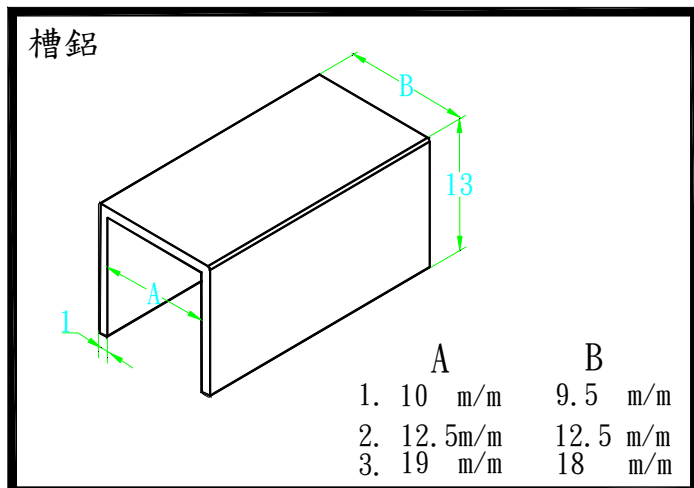

- B3031 3分槽鋁
- B3032 4分槽鋁
- B3033 6分槽鋁

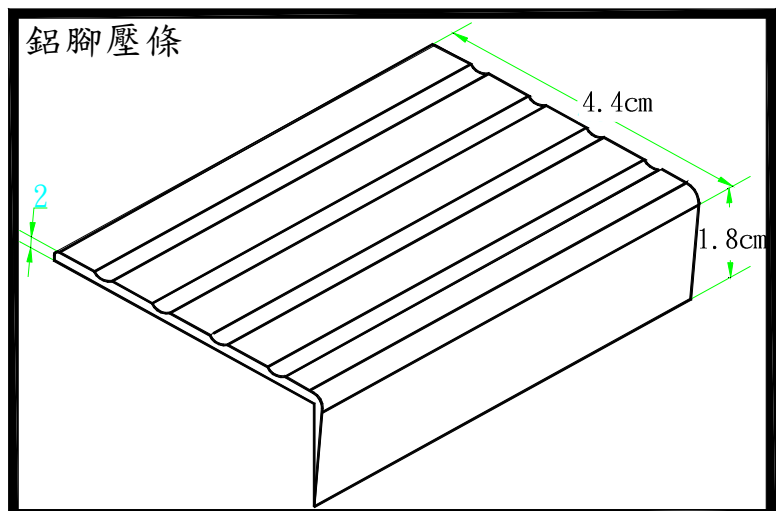
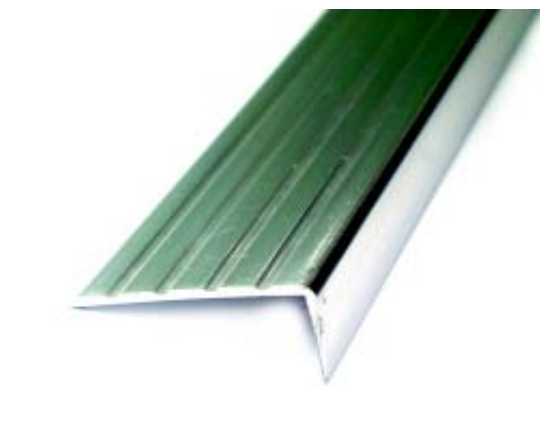

- B3051 鋁腳壓條薄鋁腳壓條 4.4x1.8x6M



B3063 T型角鋁 10mm\*10mm 6M  
B3064 T型角鋁 B 6.5MM\*6.5MM 6M

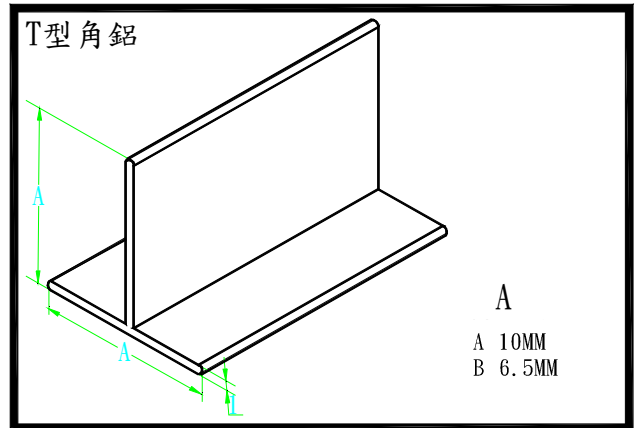

B3072 鋁壁板 5M

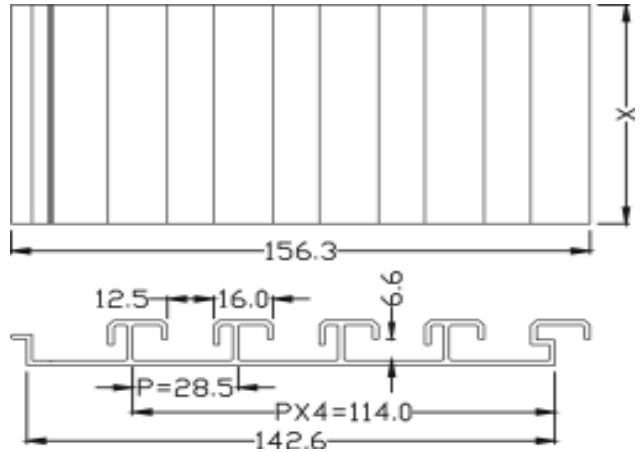

### 鋁壁板結構

如有過重或過長時，請塗上樹脂及AB膠，同時鎖上螺絲。

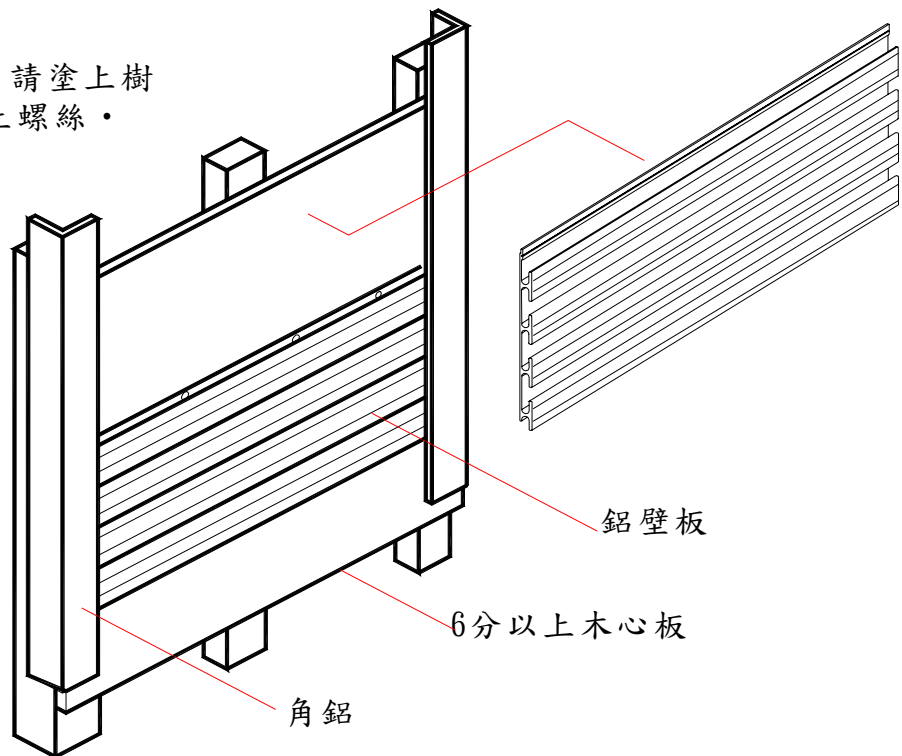



專利號碼：台灣 M242108  
日本 3099639  
中國 ZL03209647. X



B3076 專利展示塑膠壓修隔板

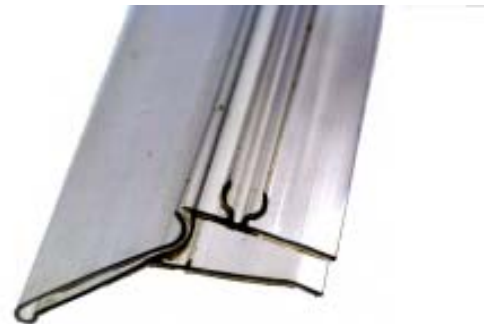

B3077 專利展示塑膠壓修隔板 - 壓條 8 尺  
B3078 專利展示塑膠壓修隔板 - 壓條 9 尺  
B3079 專利展示塑膠壓修隔板 - 壓條 12 尺





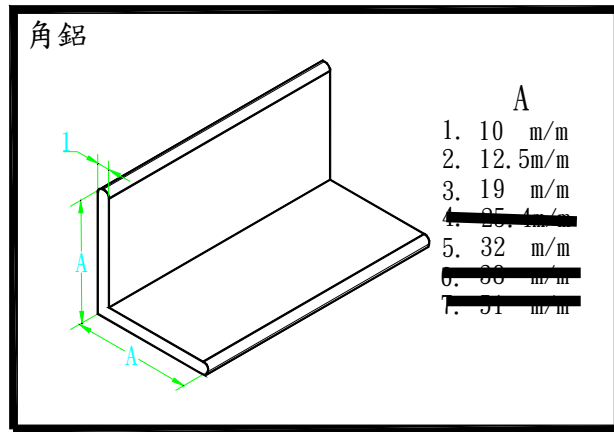
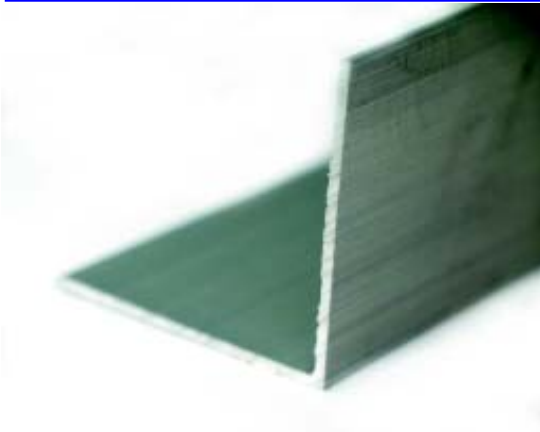

- B3011 3分角鋁
- B3012 4分角鋁
- B3013 6分角鋁
- B3015 1.1/4英吋角鋁

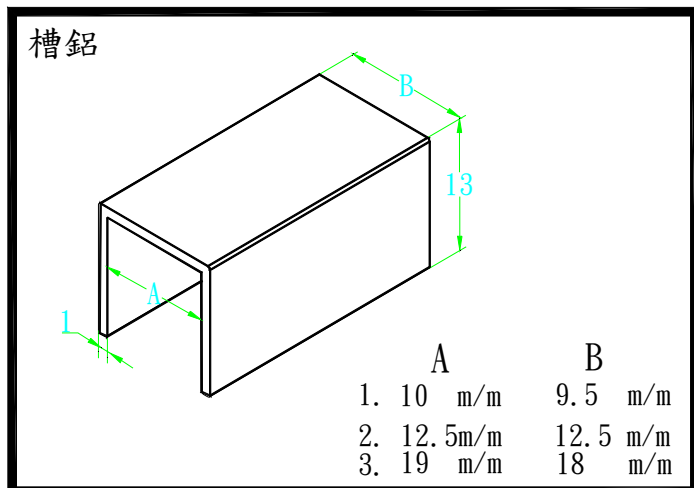
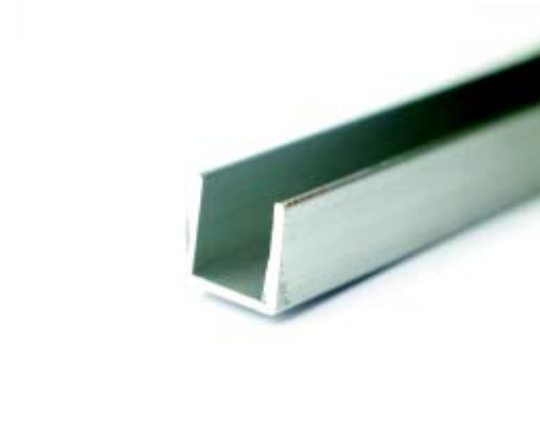

- B3031 3分槽鋁
- B3032 4分槽鋁
- B3033 6分槽鋁

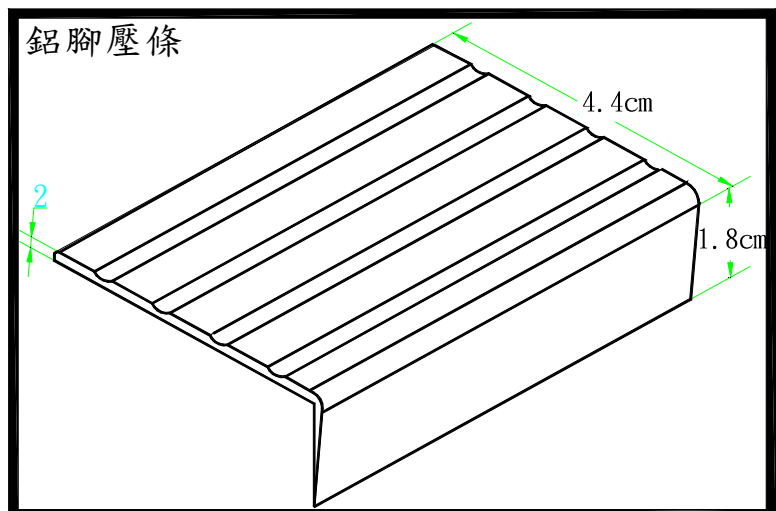
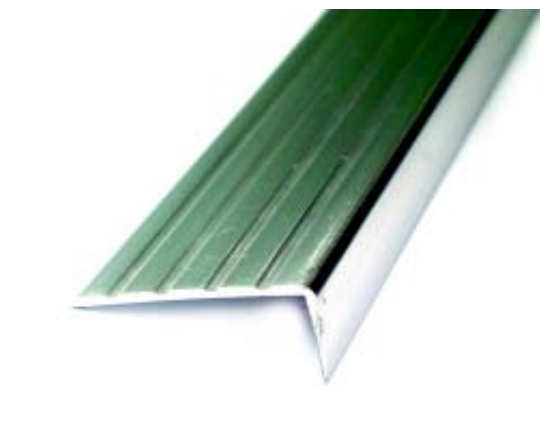

- B3051 鋁腳壓條薄鋁腳壓條 4.4x1.8x6M



B3063 T型角鋁 10mm\*10mm 6M  
B3064 T型角鋁 B 6.5MM\*6.5MM 6M

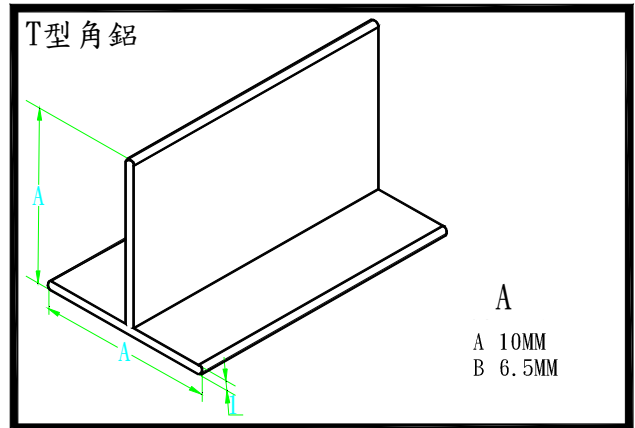

B3072 鋁壁板 5M

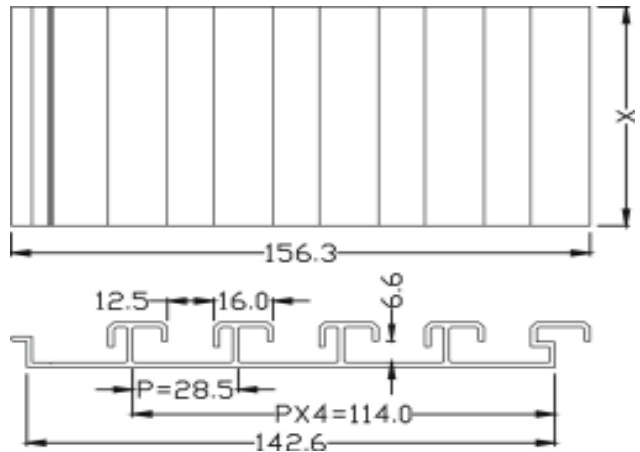

### 鋁壁板結構

如有過重或過長時，請塗上樹脂及AB膠，同時鎖上螺絲。

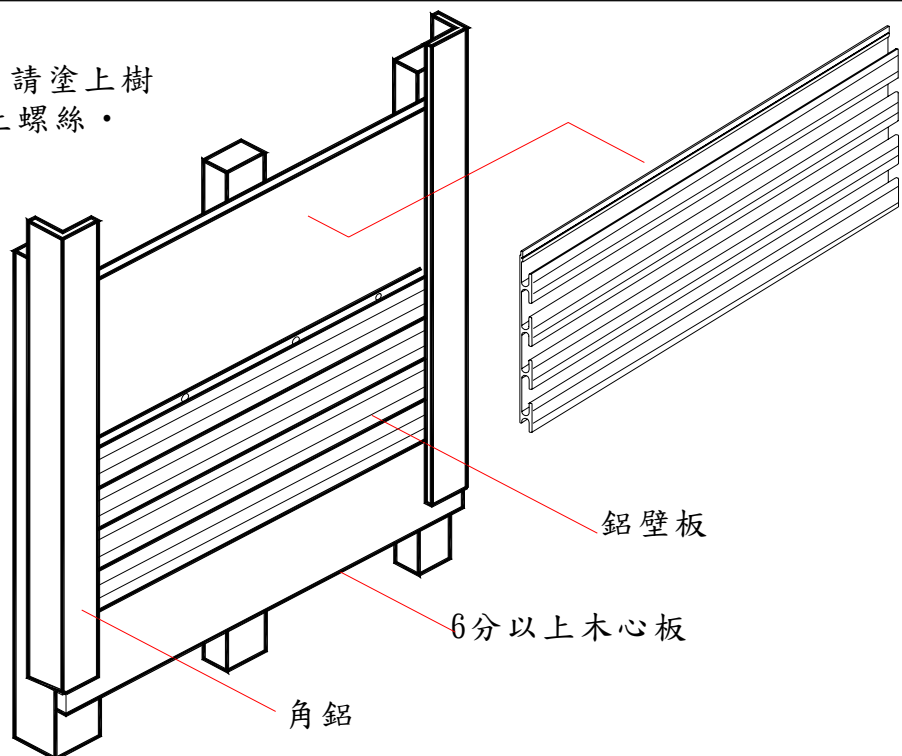



專利號碼：台灣 M242108  
日本 3099639  
中國 ZL03209647. X



B3076 專利展示塑膠壓修隔板

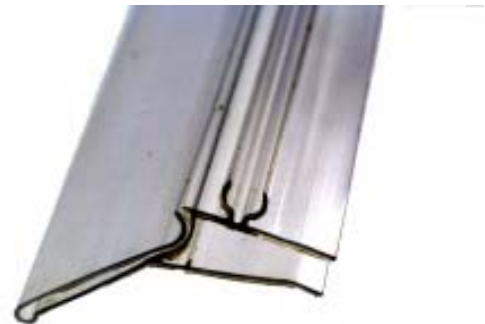

B3077 專利展示塑膠壓修隔板 - 壓條 8 尺  
B3078 專利展示塑膠壓修隔板 - 壓條 9 尺  
B3079 專利展示塑膠壓修隔板 - 壓條 12 尺



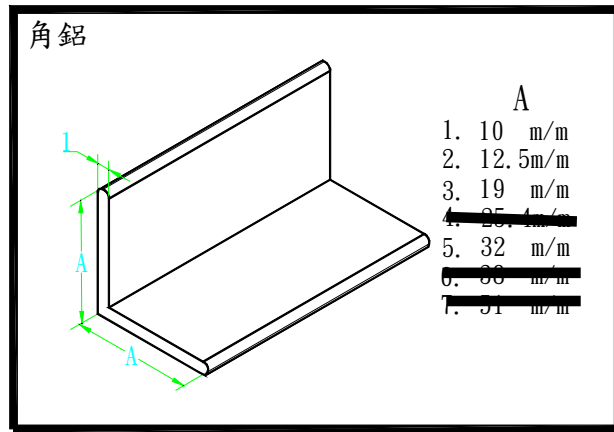
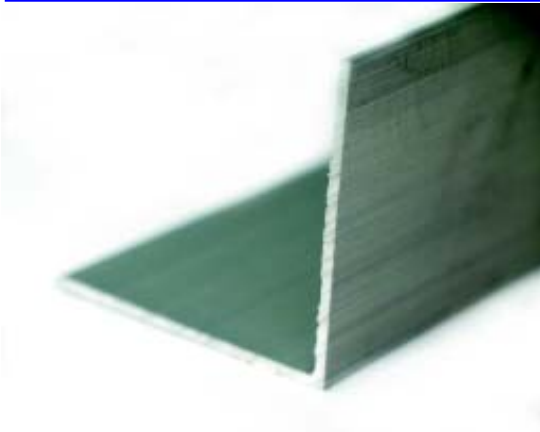

- B3011 3分角鋁
- B3012 4分角鋁
- B3013 6分角鋁
- B3015 1.1/4英吋角鋁

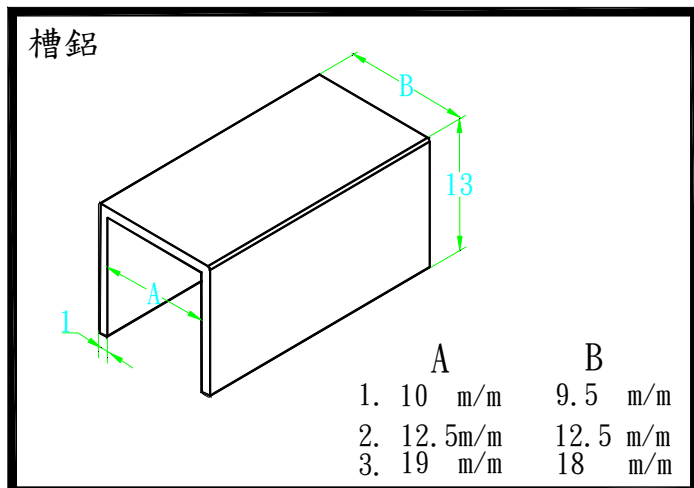
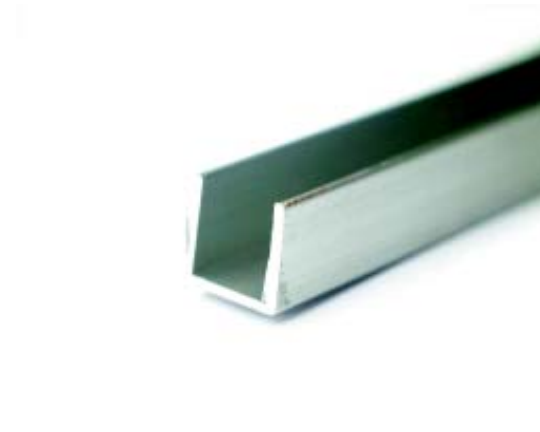

- B3031 3分槽鋁
- B3032 4分槽鋁
- B3033 6分槽鋁

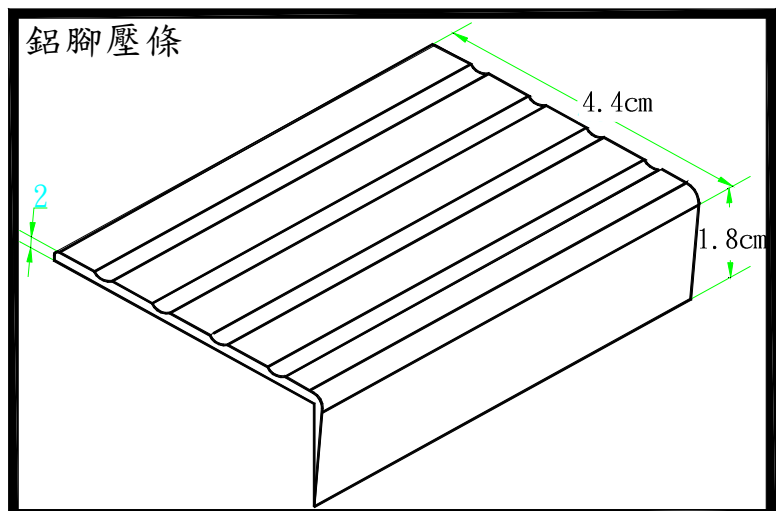
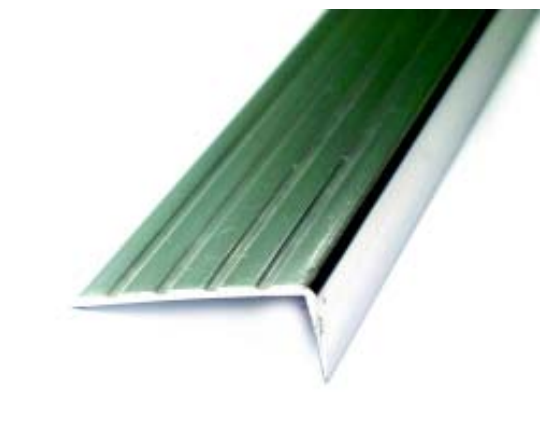

- B3051 鋁腳壓條薄鋁腳壓條 4.4x1.8x6M



B3063 T型角鋁 10mm\*10mm 6M  
B3064 T型角鋁 B 6.5MM\*6.5MM 6M

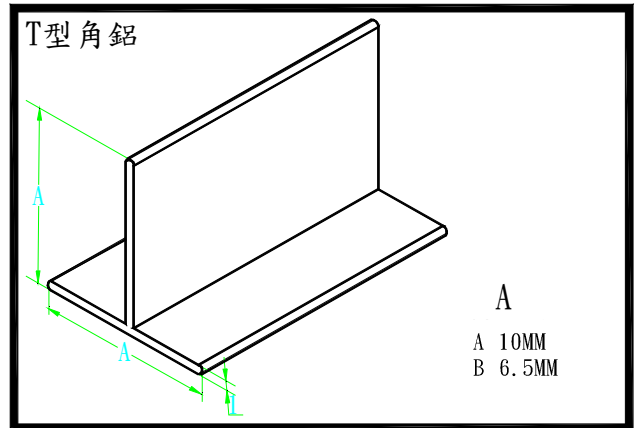

B3072 鋁壁板 5M

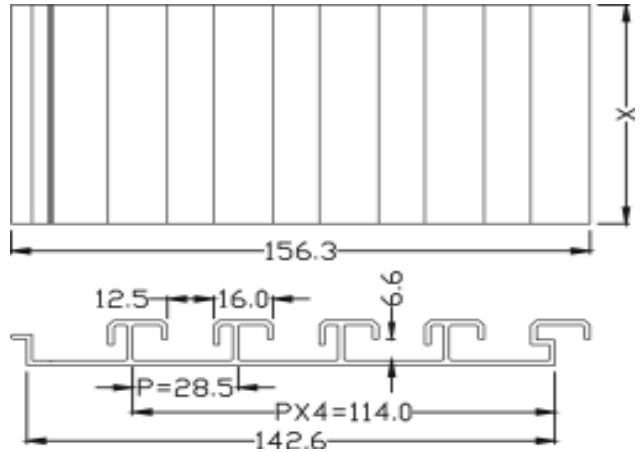

### 鋁壁板結構

如有過重或過長時，請塗上樹脂及AB膠，同時鎖上螺絲。

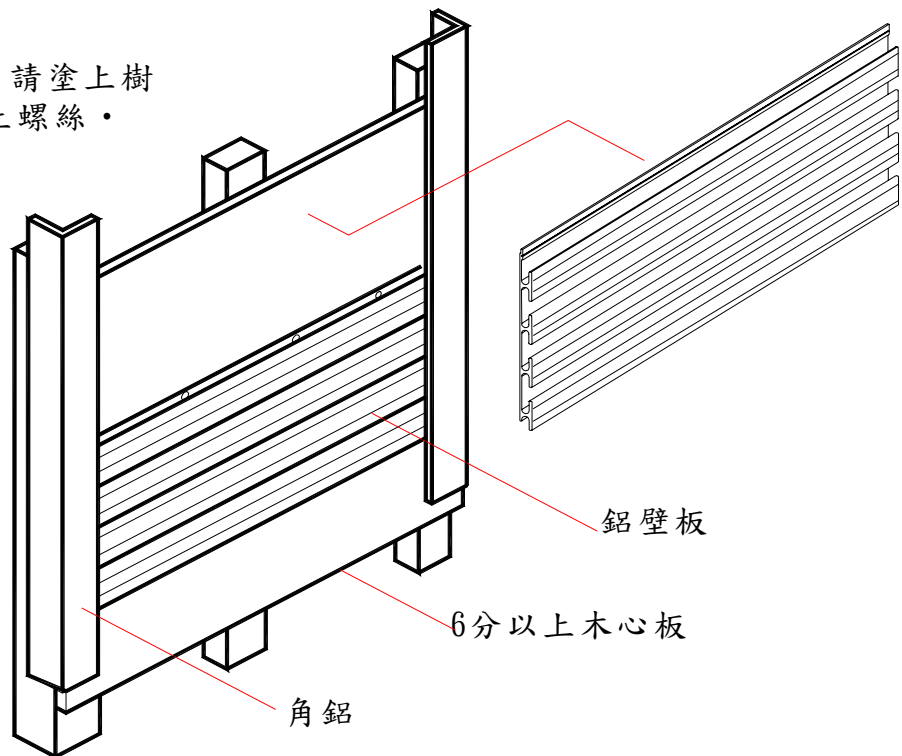



專利號碼：台灣 M242108  
日本 3099639  
中國 ZL03209647. X



B3076 專利展示塑膠壓修隔板

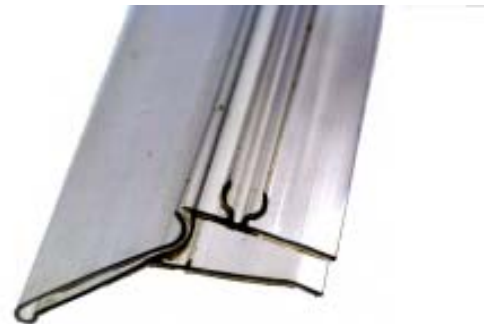

B3077 專利展示塑膠壓修隔板 - 壓條 8 尺  
B3078 專利展示塑膠壓修隔板 - 壓條 9 尺  
B3079 專利展示塑膠壓修隔板 - 壓條 12 尺





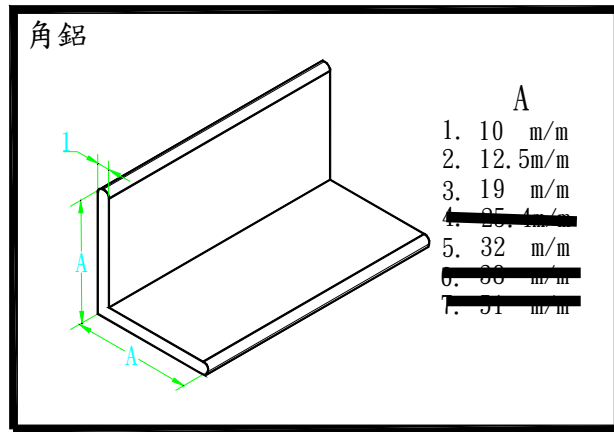
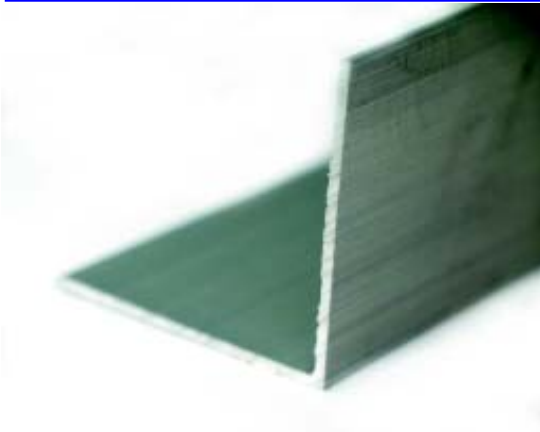

- B3011 3分角鋁
- B3012 4分角鋁
- B3013 6分角鋁
- B3015 1.1/4英吋角鋁

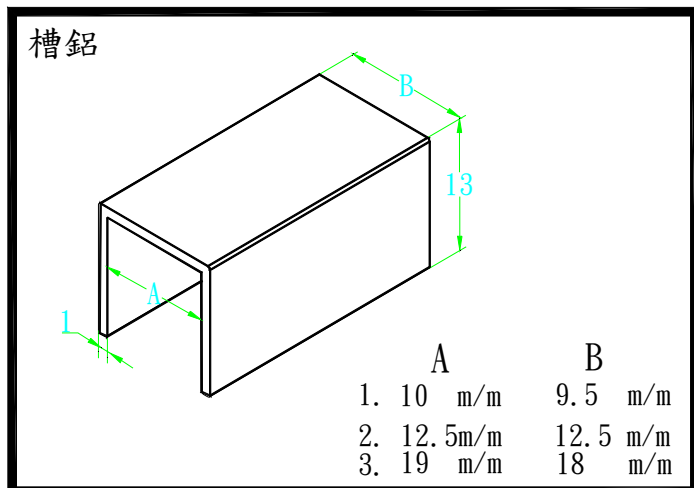
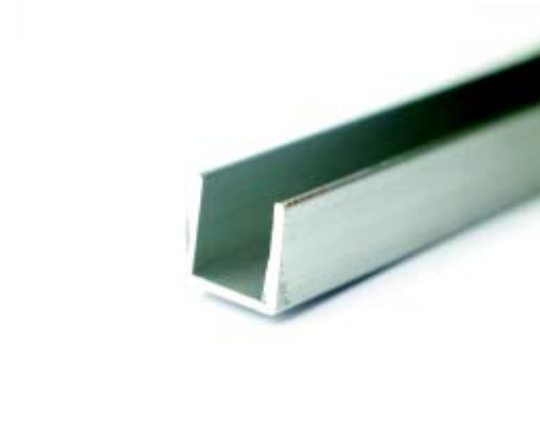

- B3031 3分槽鋁
- B3032 4分槽鋁
- B3033 6分槽鋁

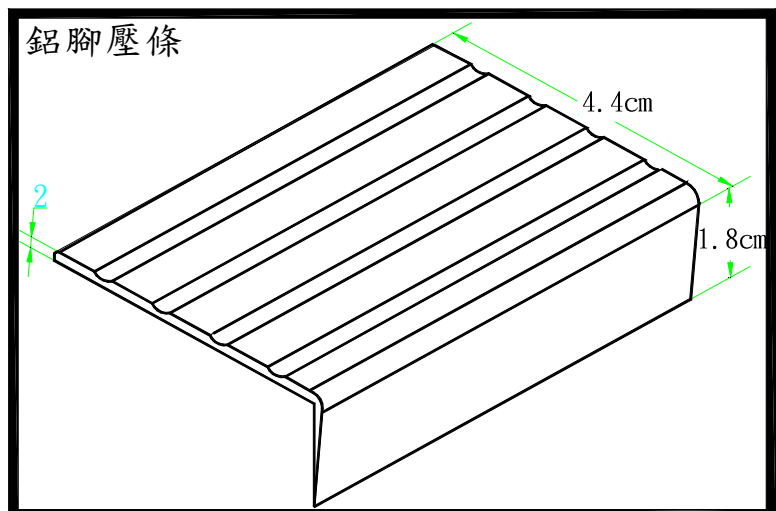
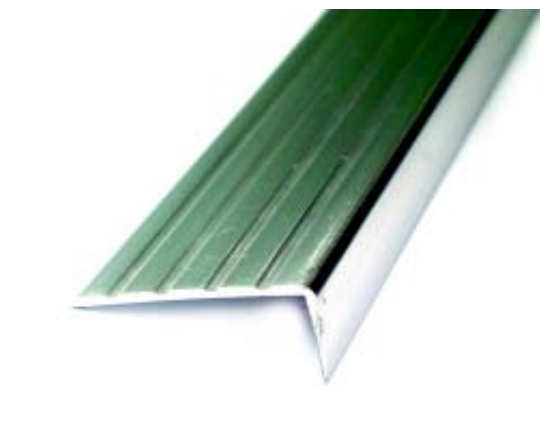

- B3051 鋁腳壓條薄鋁腳壓條 4.4x1.8x6M



B3063 T型角鋁 10mm\*10mm 6M  
B3064 T型角鋁 B 6.5MM\*6.5MM 6M

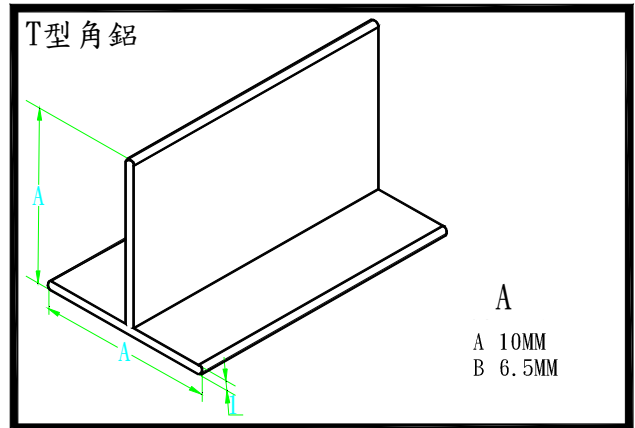

B3072 鋁壁板 5M

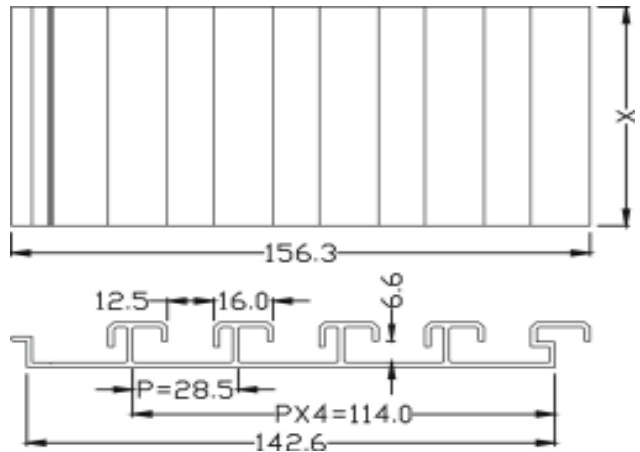

### 鋁壁板結構

如有過重或過長時，請塗上樹脂及AB膠，同時鎖上螺絲。

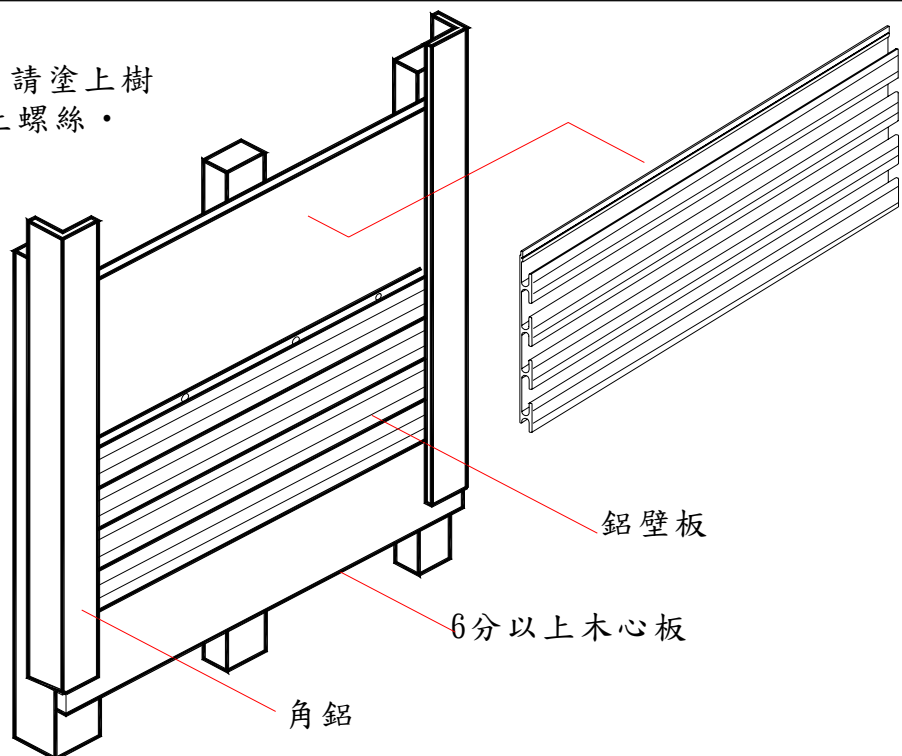



專利號碼：台灣 M242108  
日本 3099639  
中國 ZL03209647. X



B3076 專利展示塑膠壓修隔板

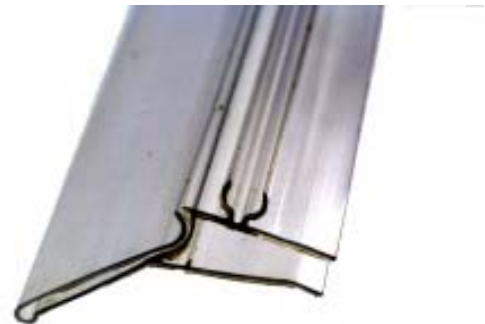

B3077 專利展示塑膠壓修隔板 - 壓條 8 尺  
B3078 專利展示塑膠壓修隔板 - 壓條 9 尺  
B3079 專利展示塑膠壓修隔板 - 壓條 12 尺



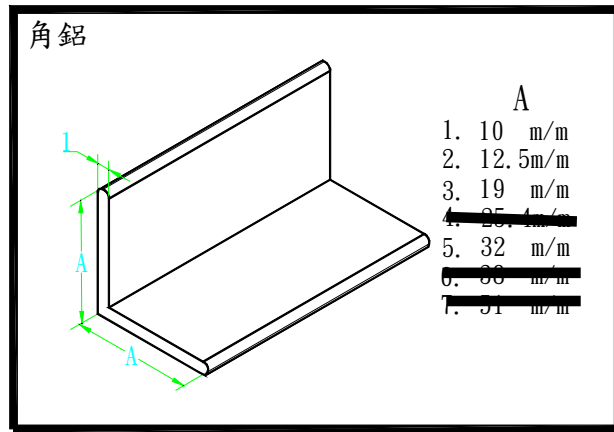
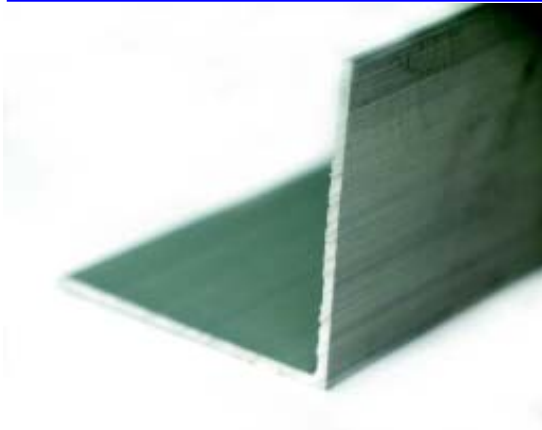

- B3011 3分角鋁
- B3012 4分角鋁
- B3013 6分角鋁
- B3015 1.1/4 英寸角鋁

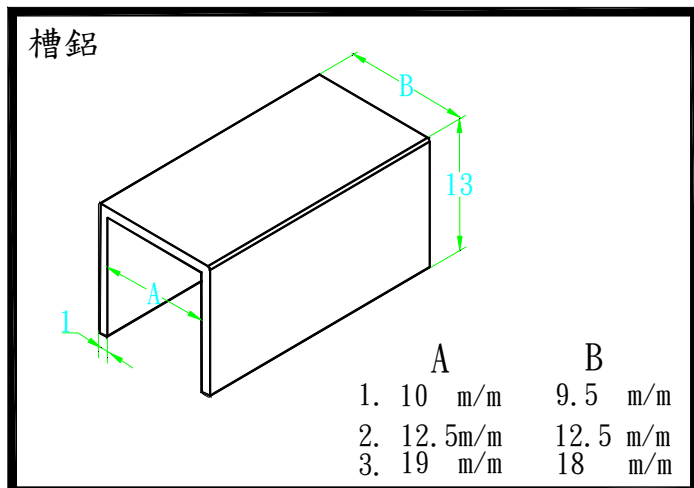
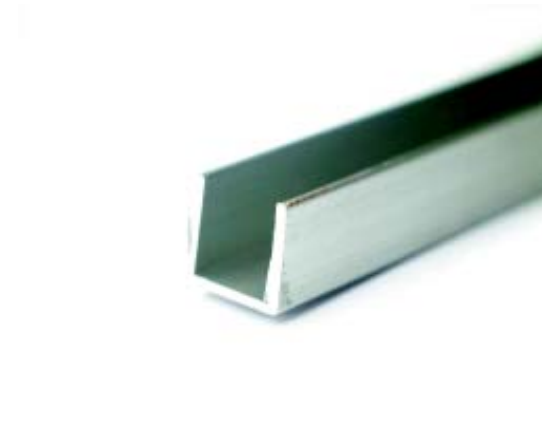

- B3031 3分槽鋁
- B3032 4分槽鋁
- B3033 6分槽鋁

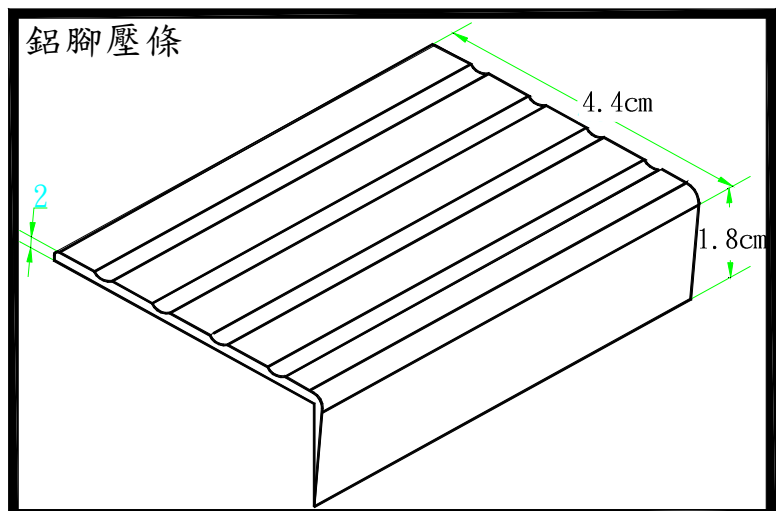
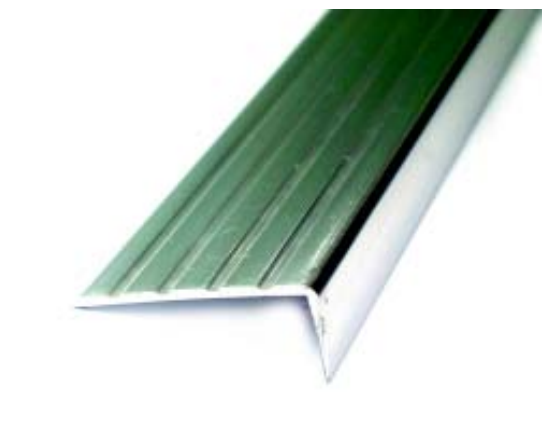

- B3051 鋁腳壓條薄鋁腳壓條 4.4x1.8x6M



B3063 T型角鋁 10mm\*10mm 6M  
B3064 T型角鋁 B 6.5MM\*6.5MM 6M

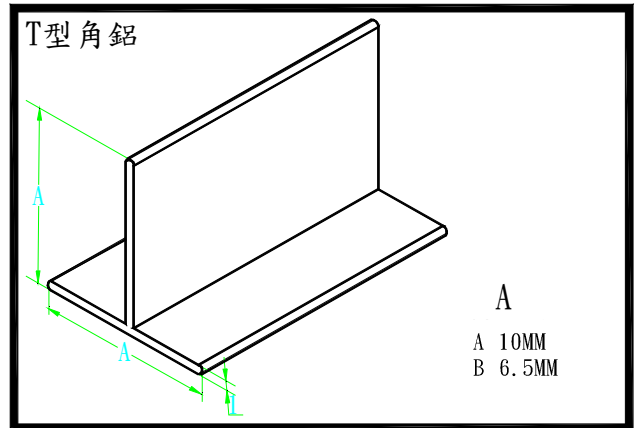

B3072 鋁壁板 5M

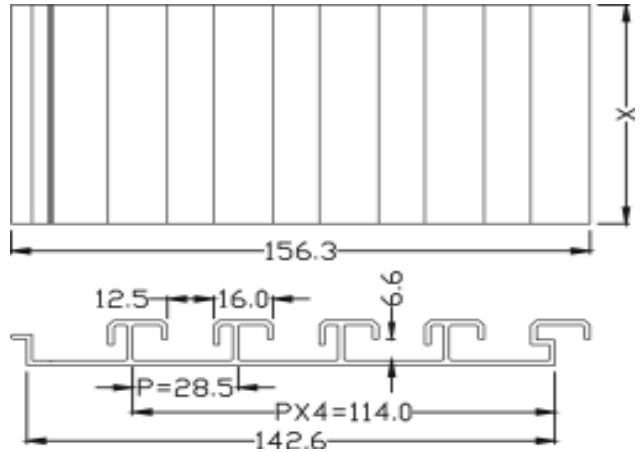

### 鋁壁板結構

如有過重或過長時，請塗上樹脂及AB膠，同時鎖上螺絲。

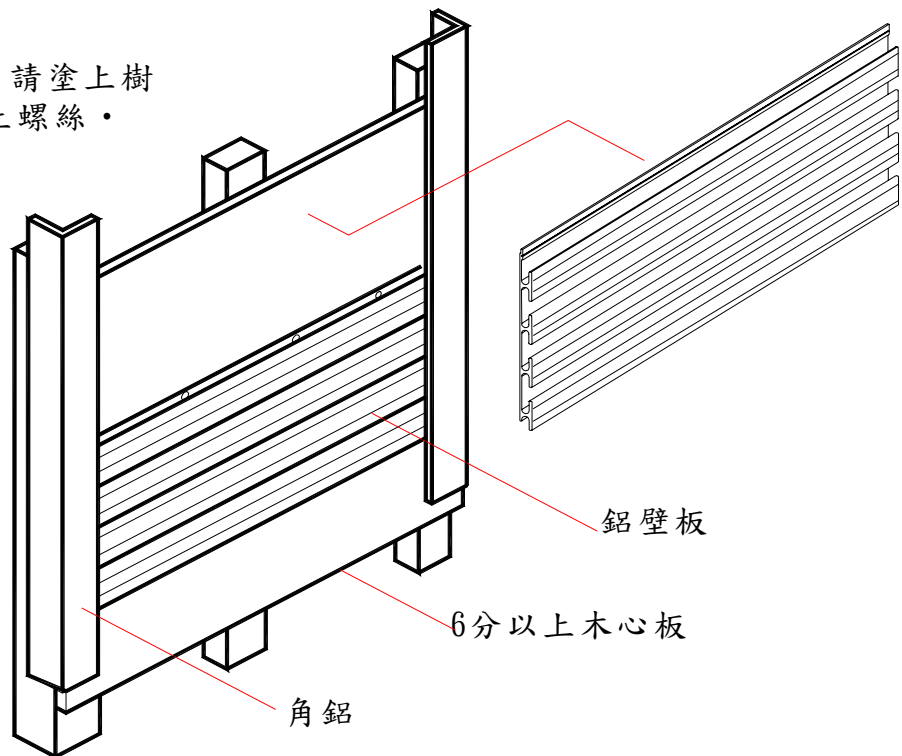



專利號碼：台灣 M242108  
日本 3099639  
中國 ZL03209647. X



B3076 專利展示塑膠壓修隔板

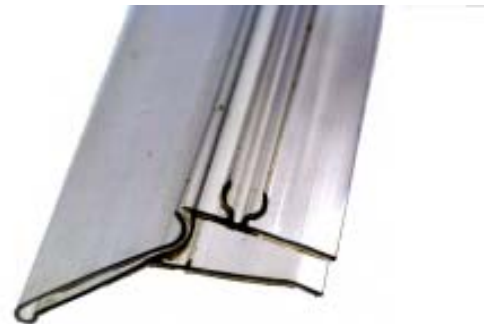

B3077 專利展示塑膠壓修隔板 - 壓條 8 尺  
B3078 專利展示塑膠壓修隔板 - 壓條 9 尺  
B3079 專利展示塑膠壓修隔板 - 壓條 12 尺





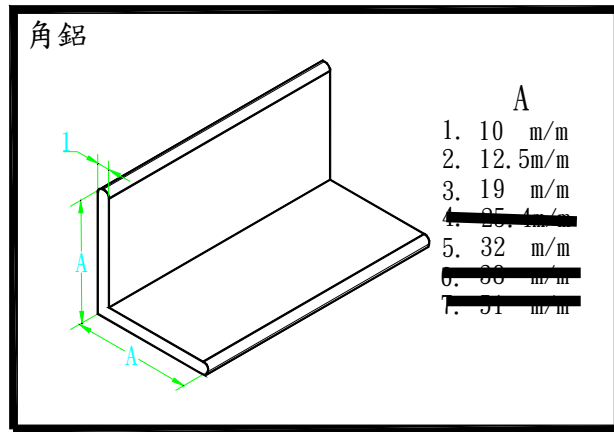
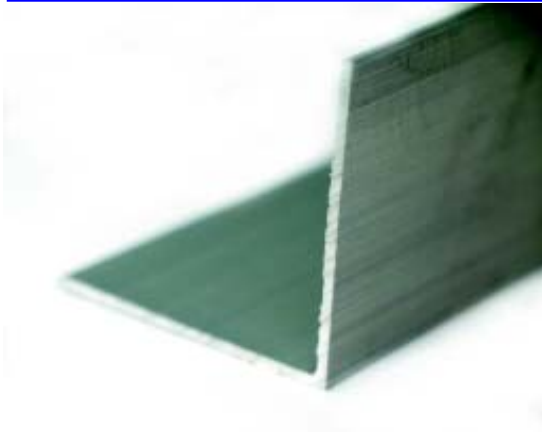

- B3011 3分角鋁
- B3012 4分角鋁
- B3013 6分角鋁
- B3015 1.1/4英吋角鋁

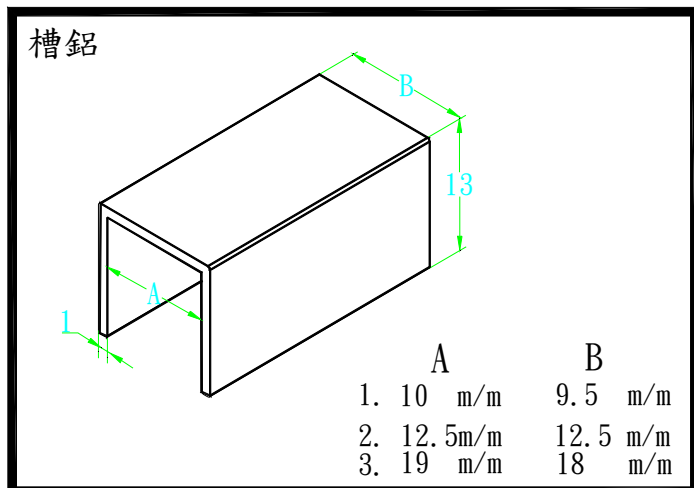
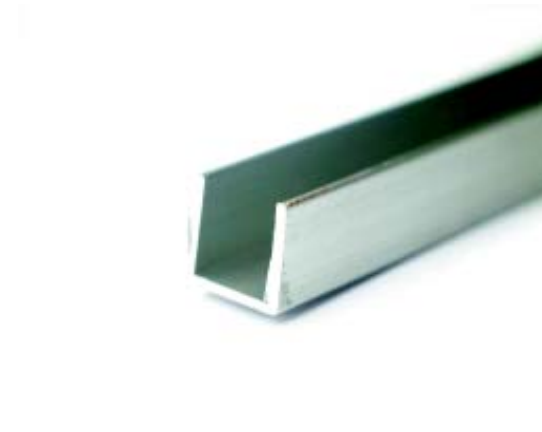

- B3031 3分槽鋁
- B3032 4分槽鋁
- B3033 6分槽鋁

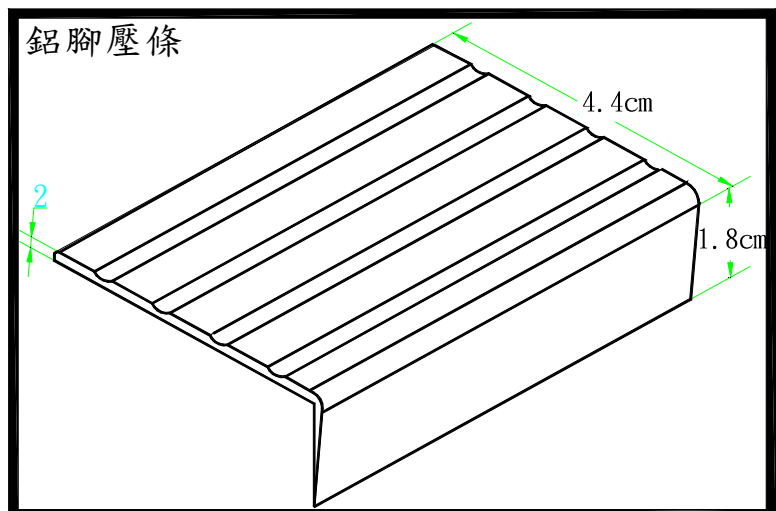
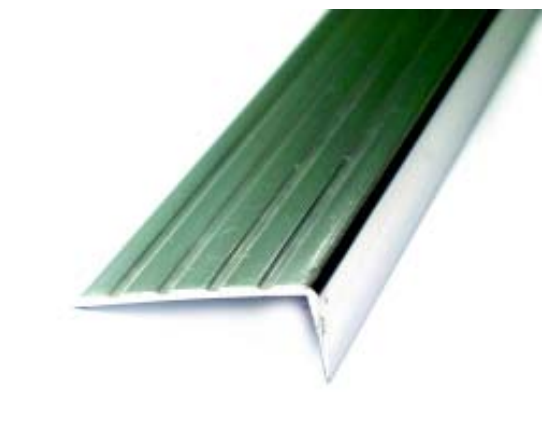

- B3051 鋁腳壓條薄鋁腳壓條 4.4x1.8x6M



B3063 T型角鋁 10mm\*10mm 6M  
B3064 T型角鋁 B 6.5MM\*6.5MM 6M

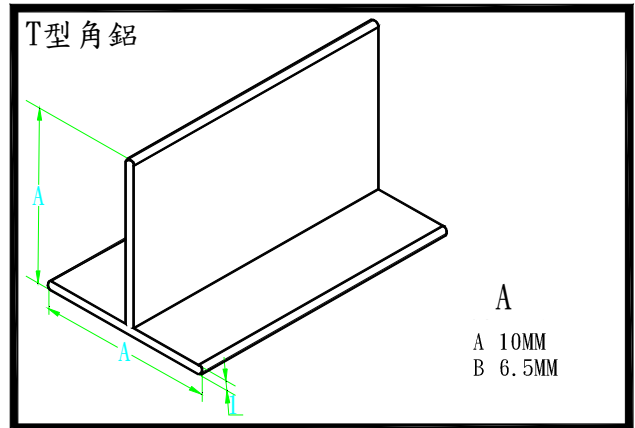

B3072 鋁壁板 5M

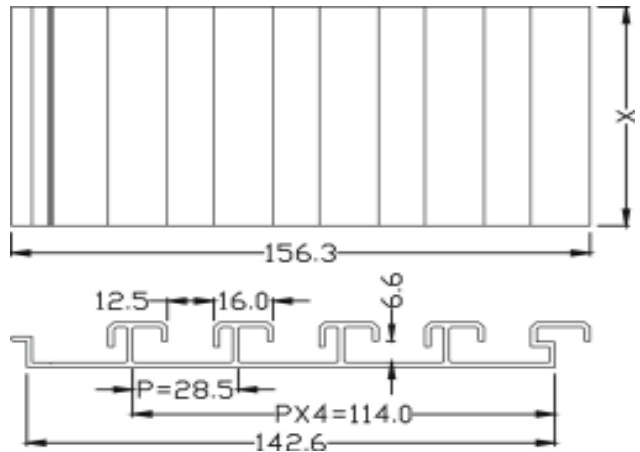

### 鋁壁板結構

如有過重或過長時，請塗上樹脂及AB膠，同時鎖上螺絲。

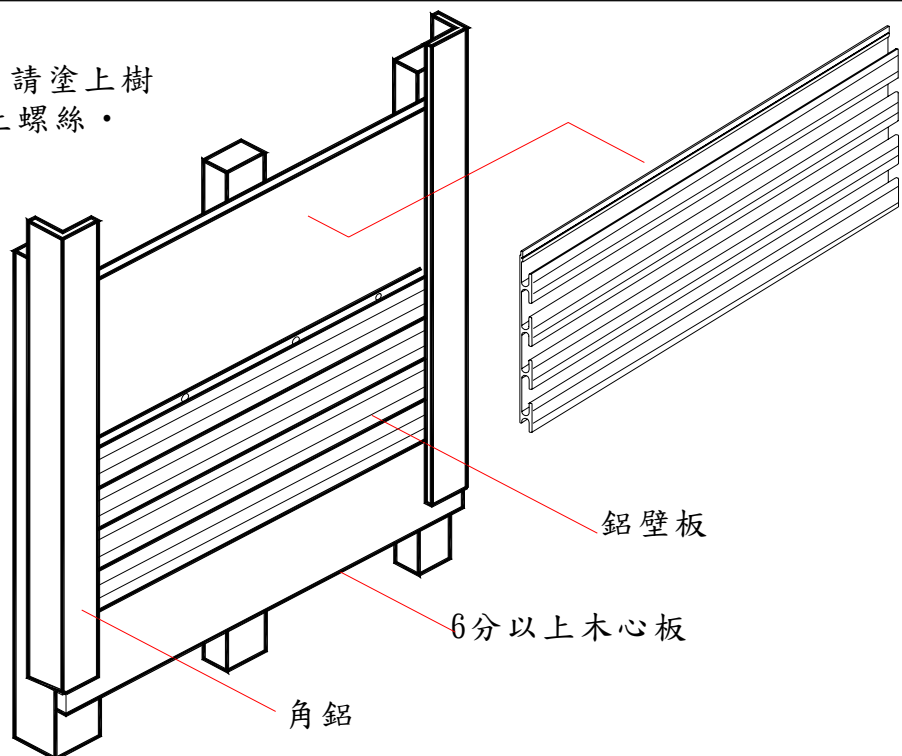



專利號碼：台灣 M242108  
日本 3099639  
中國 ZL03209647. X



B3076 專利展示塑膠壓修隔板

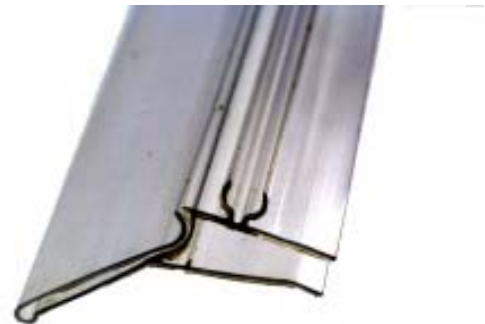

B3077 專利展示塑膠壓修隔板 - 壓條 8 尺  
B3078 專利展示塑膠壓修隔板 - 壓條 9 尺  
B3079 專利展示塑膠壓修隔板 - 壓條 12 尺



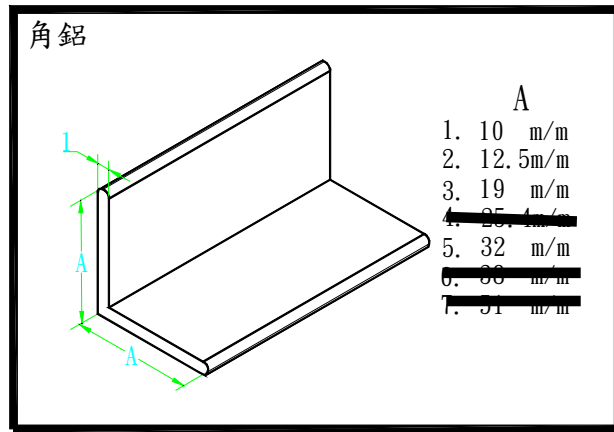
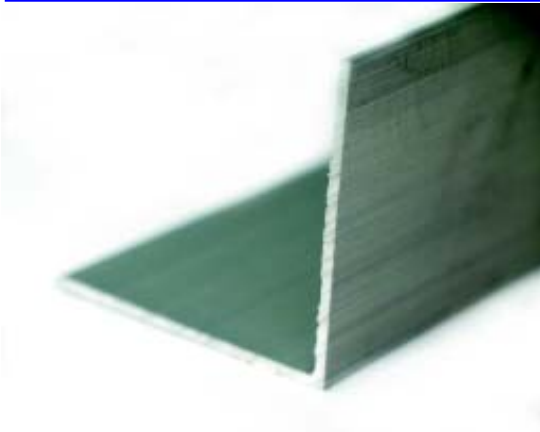

- B3011 3分角鋁
- B3012 4分角鋁
- B3013 6分角鋁
- B3015 1.1/4英吋角鋁

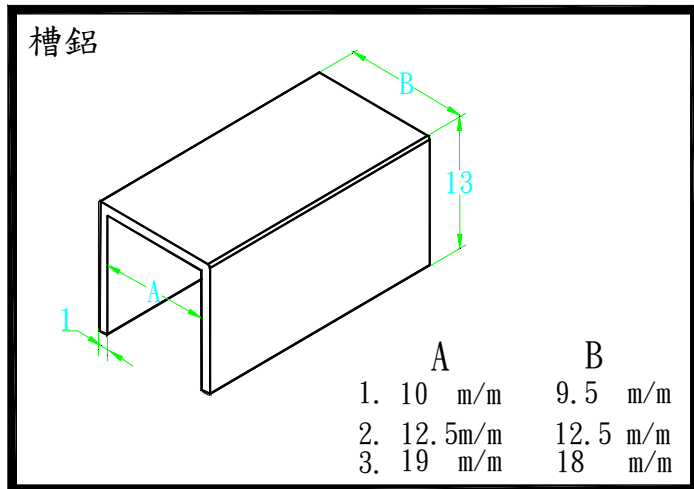
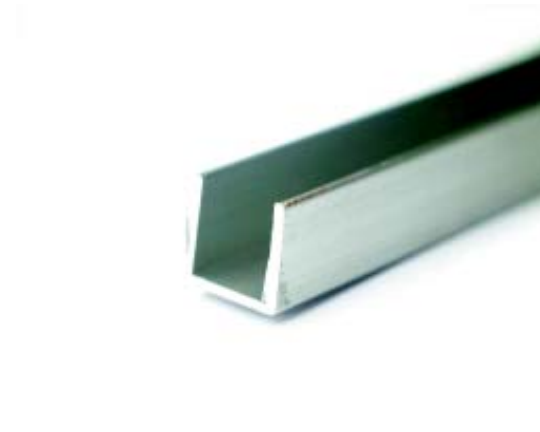

- B3031 3分槽鋁
- B3032 4分槽鋁
- B3033 6分槽鋁

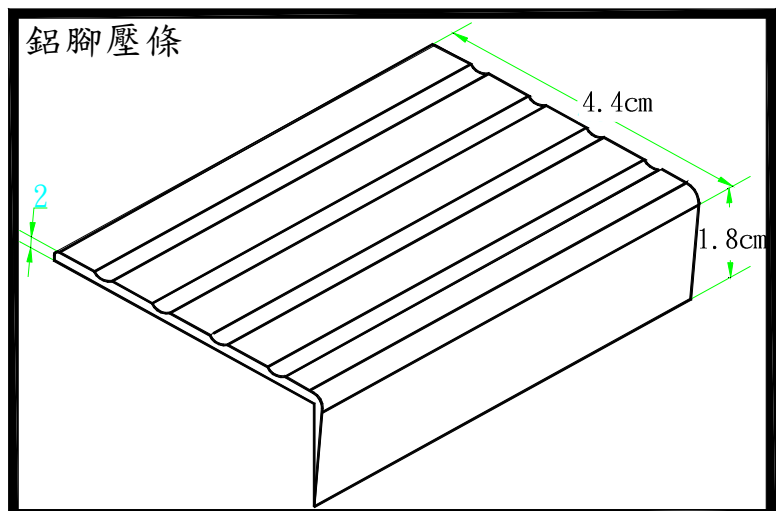
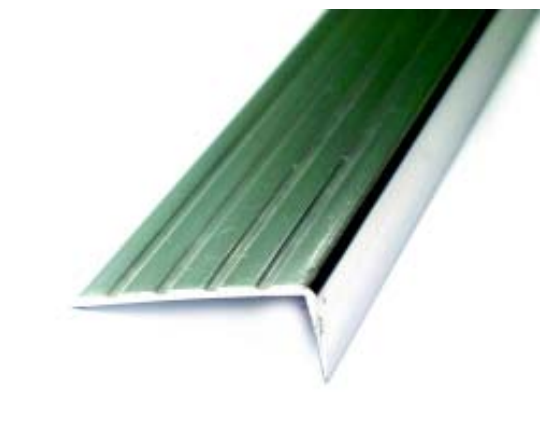

- B3051 鋁腳壓條薄鋁腳壓條 4.4x1.8x6M



B3063 T型角鋁 10mm\*10mm 6M  
B3064 T型角鋁 B 6.5MM\*6.5MM 6M

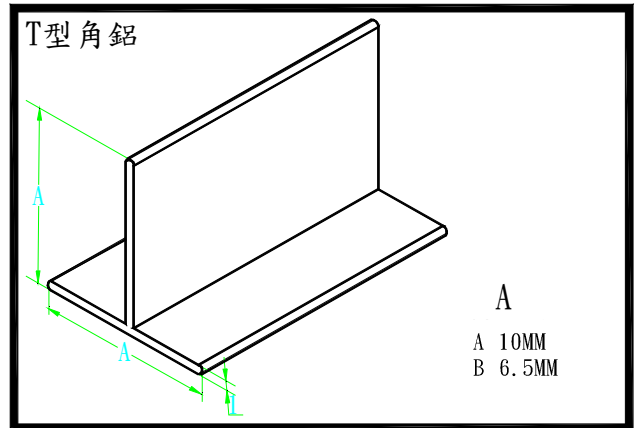

B3072 鋁壁板 5M

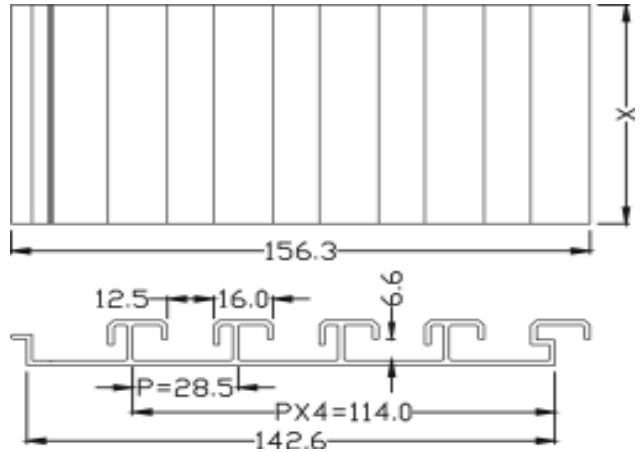

### 鋁壁板結構

如有過重或過長時，請塗上樹脂及AB膠，同時鎖上螺絲。

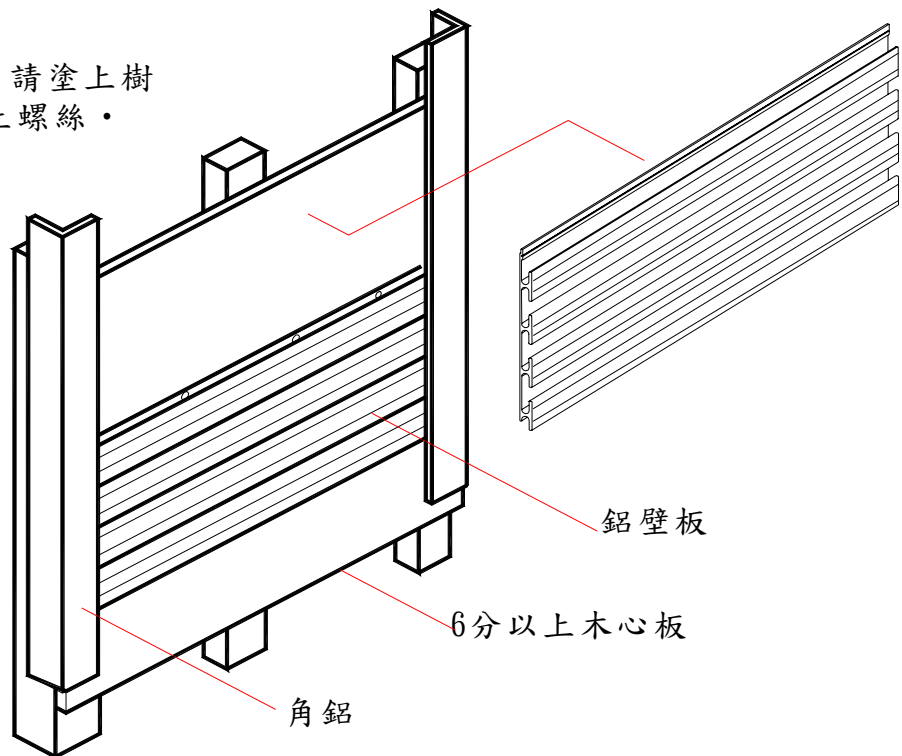



專利號碼：台灣 M242108  
日本 3099639  
中國 ZL03209647. X



B3076 專利展示塑膠壓修隔板

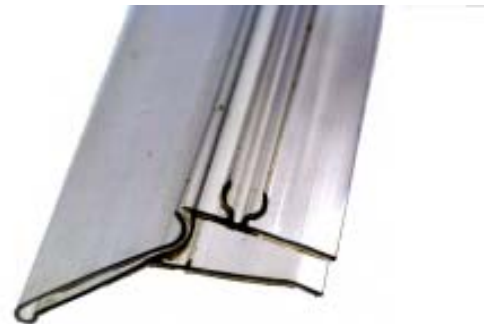

B3077 專利展示塑膠壓修隔板 - 壓條 8 尺  
B3078 專利展示塑膠壓修隔板 - 壓條 9 尺  
B3079 專利展示塑膠壓修隔板 - 壓條 12 尺





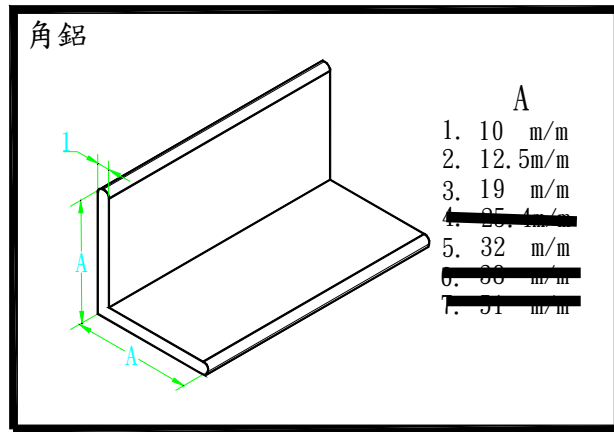
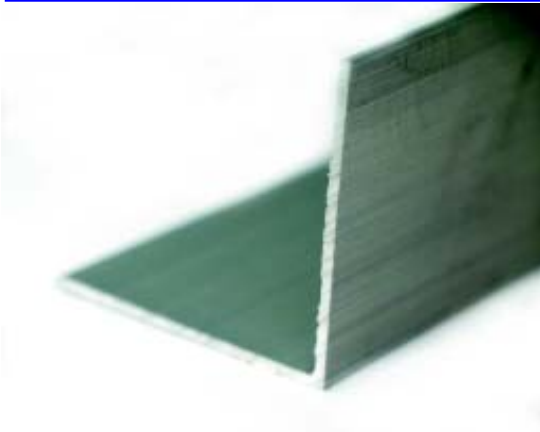

- B3011 3分角鋁
- B3012 4分角鋁
- B3013 6分角鋁
- B3015 1.1/4英吋角鋁

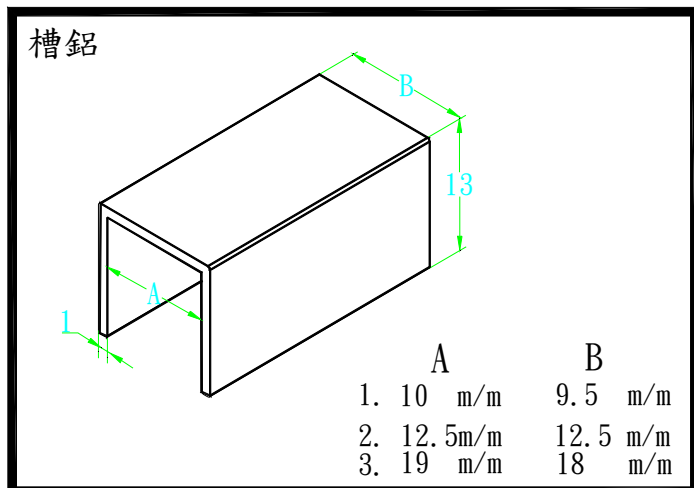
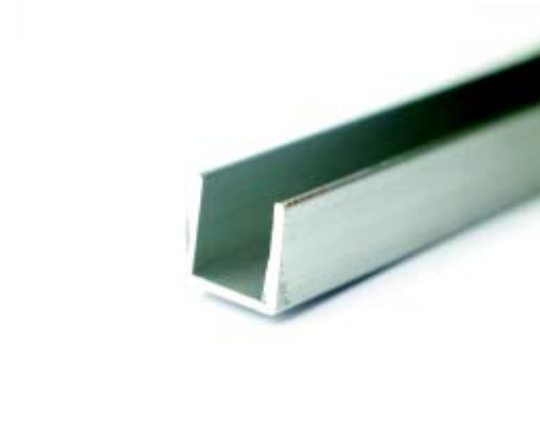

- B3031 3分槽鋁
- B3032 4分槽鋁
- B3033 6分槽鋁

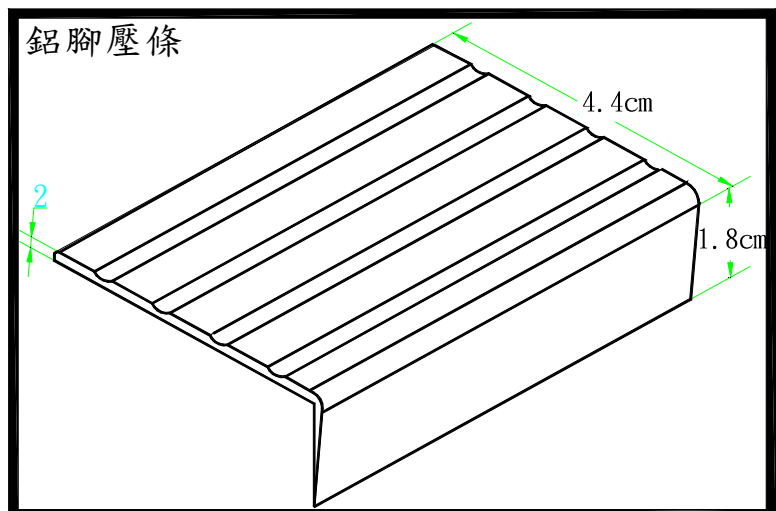
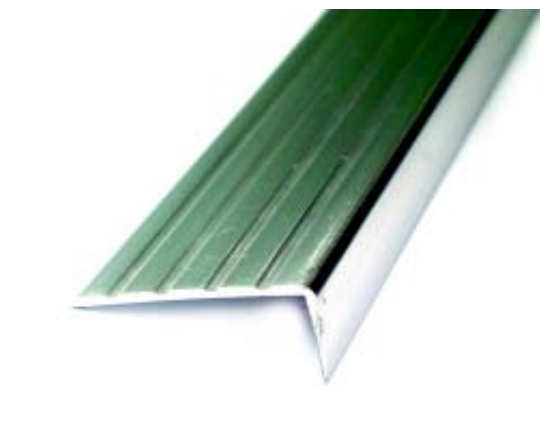

- B3051 鋁腳壓條薄鋁腳壓條 4.4x1.8x6M



B3063 T型角鋁 10mm\*10mm 6M  
B3064 T型角鋁 B 6.5MM\*6.5MM 6M

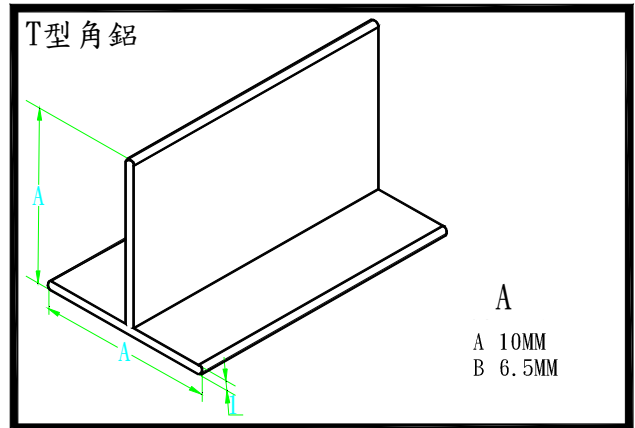

B3072 鋁壁板 5M

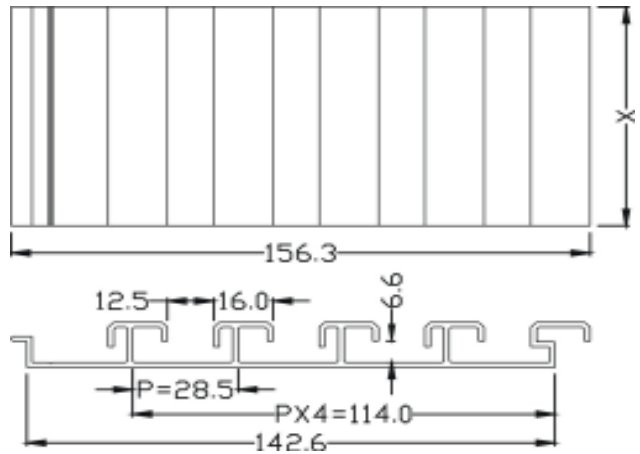

### 鋁壁板結構

如有過重或過長時，請塗上樹脂及AB膠，同時鎖上螺絲。

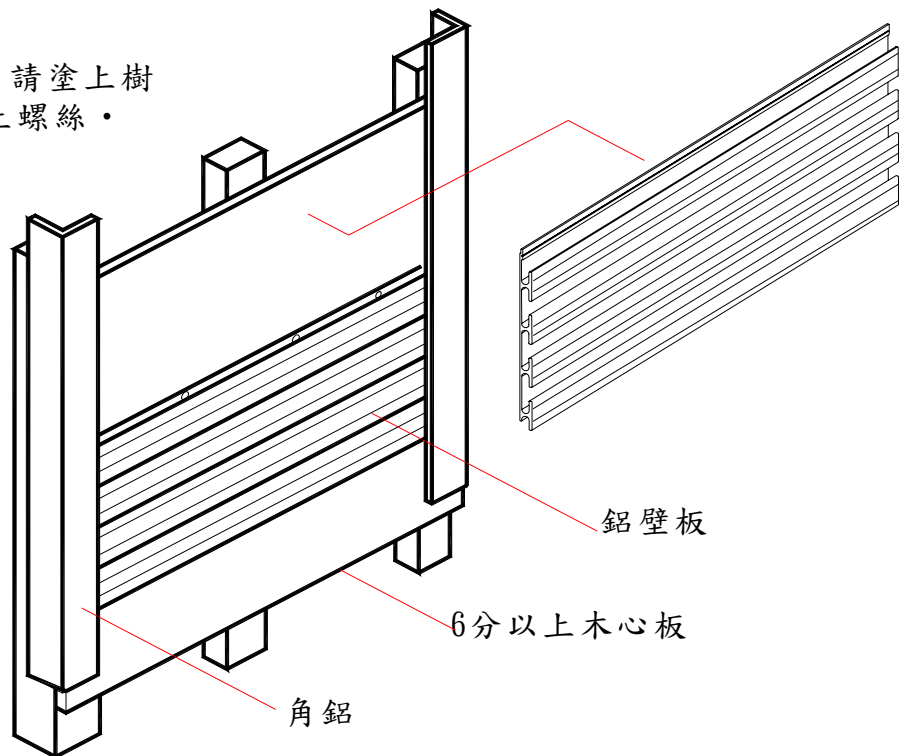



專利號碼：台灣 M242108  
日本 3099639  
中國 ZL03209647. X



B3076 專利展示塑膠壓修隔板

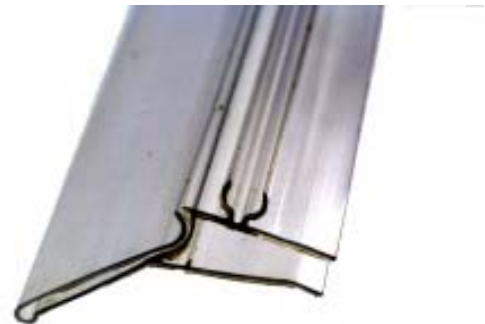

B3077 專利展示塑膠壓修隔板 - 壓條 8 尺  
B3078 專利展示塑膠壓修隔板 - 壓條 9 尺  
B3079 專利展示塑膠壓修隔板 - 壓條 12 尺



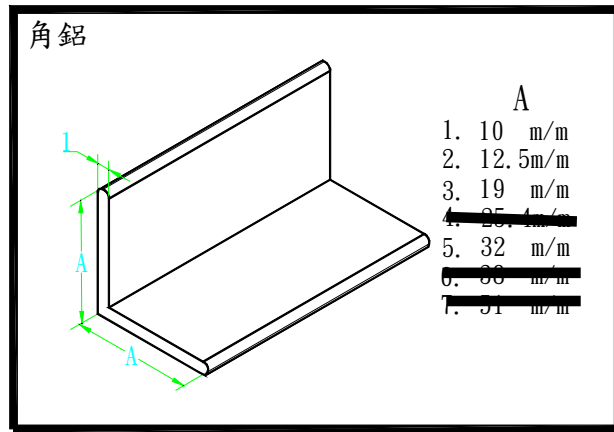
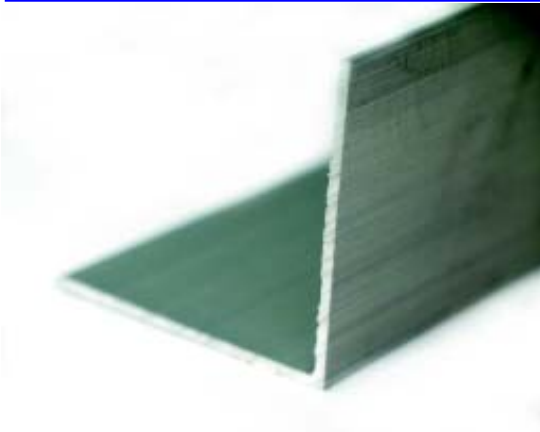

- B3011 3分角鋁
- B3012 4分角鋁
- B3013 6分角鋁
- B3015 1.1/4英吋角鋁

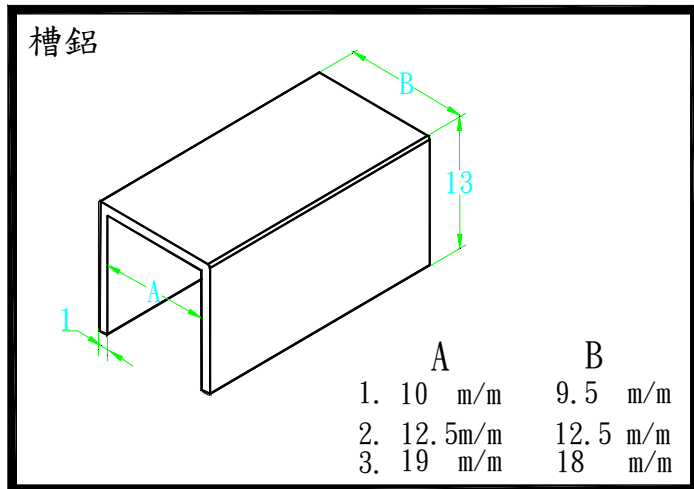
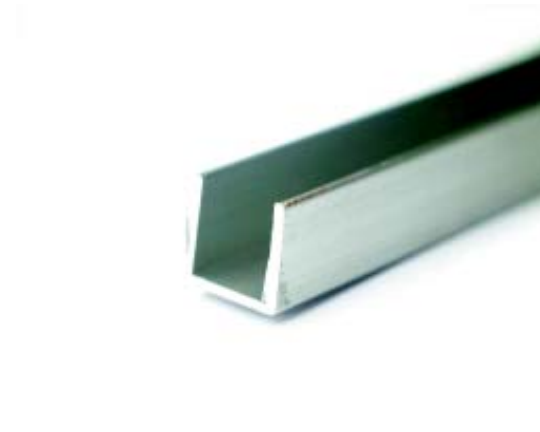

- B3031 3分槽鋁
- B3032 4分槽鋁
- B3033 6分槽鋁

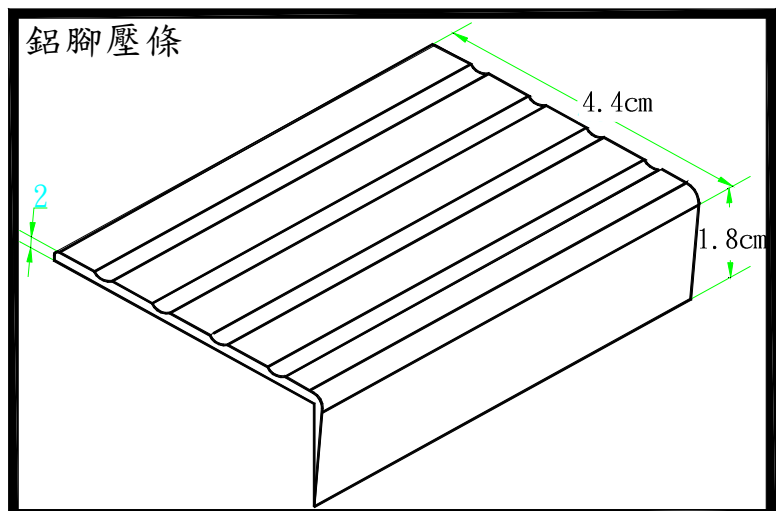
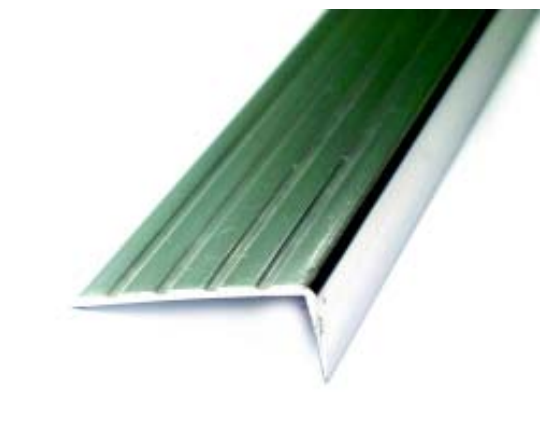

- B3051 鋁腳壓條薄鋁腳壓條 4.4x1.8x6M



B3063 T型角鋁 10mm\*10mm 6M  
B3064 T型角鋁 B 6.5MM\*6.5MM 6M

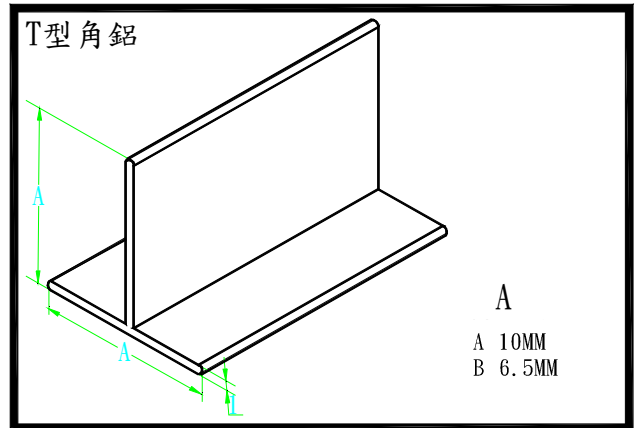

B3072 鋁壁板 5M

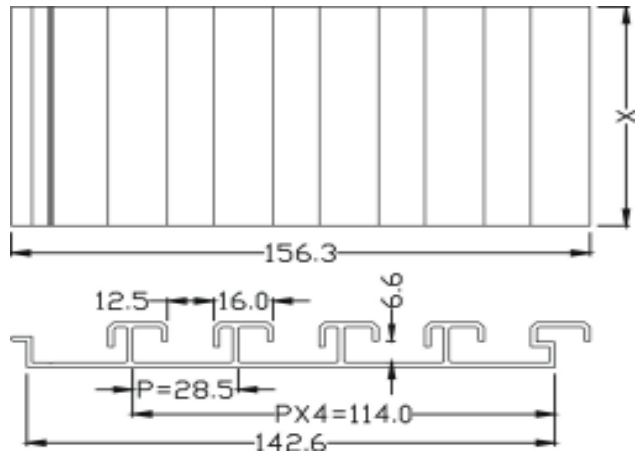

### 鋁壁板結構

如有過重或過長時，請塗上樹脂及AB膠，同時鎖上螺絲。

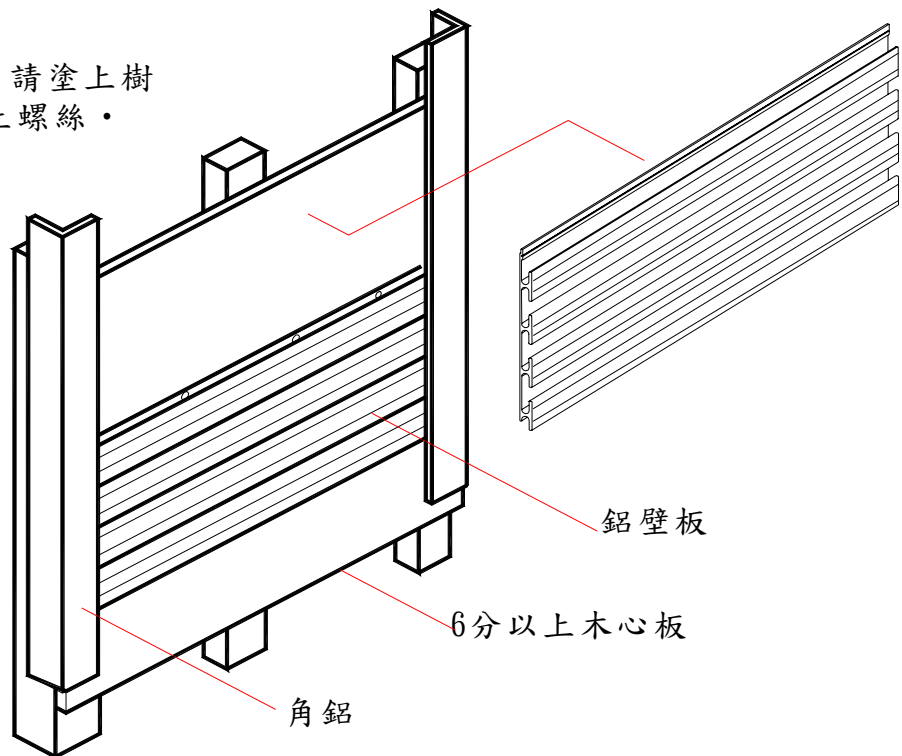



專利號碼：台灣 M242108  
日本 3099639  
中國 ZL03209647. X



B3076 專利展示塑膠壓修隔板

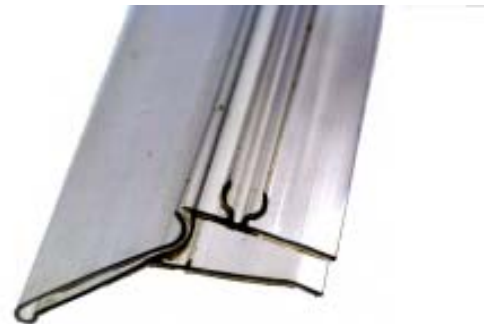

B3077 專利展示塑膠壓修隔板 - 壓條 8 尺  
B3078 專利展示塑膠壓修隔板 - 壓條 9 尺  
B3079 專利展示塑膠壓修隔板 - 壓條 12 尺





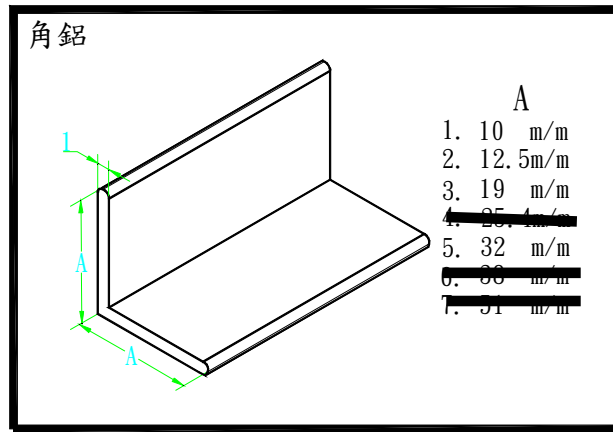
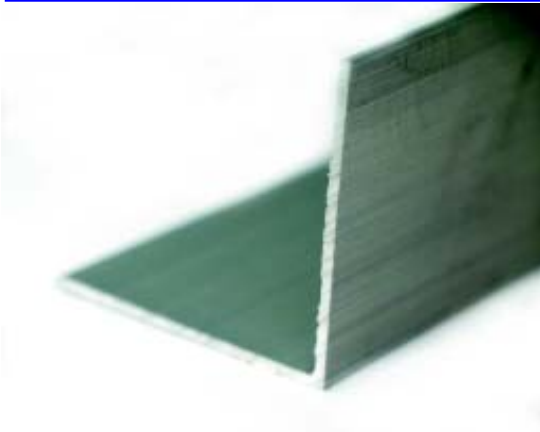

- B3011 3分角鋁
- B3012 4分角鋁
- B3013 6分角鋁
- B3015 1.1/4英吋角鋁

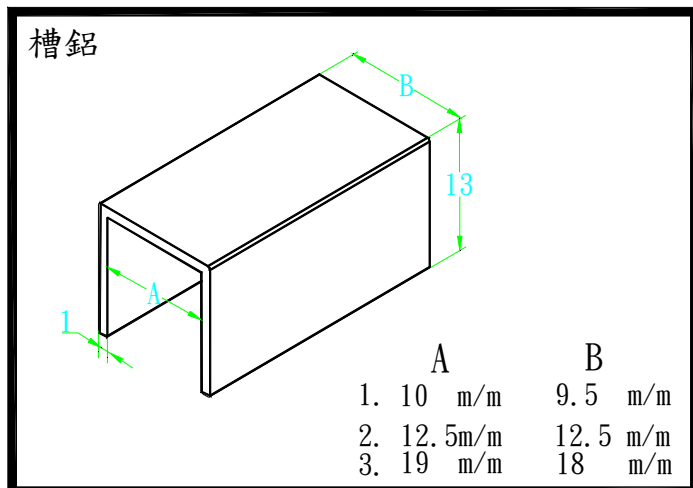
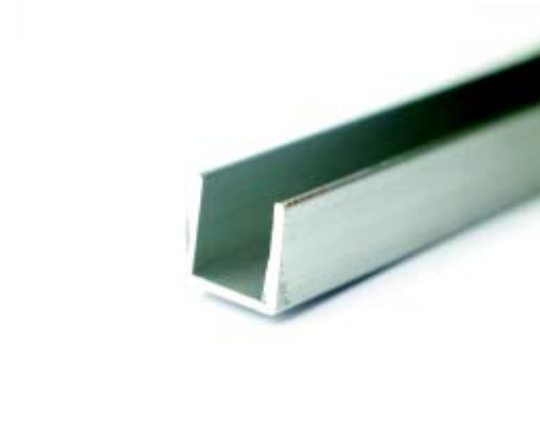

- B3031 3分槽鋁
- B3032 4分槽鋁
- B3033 6分槽鋁

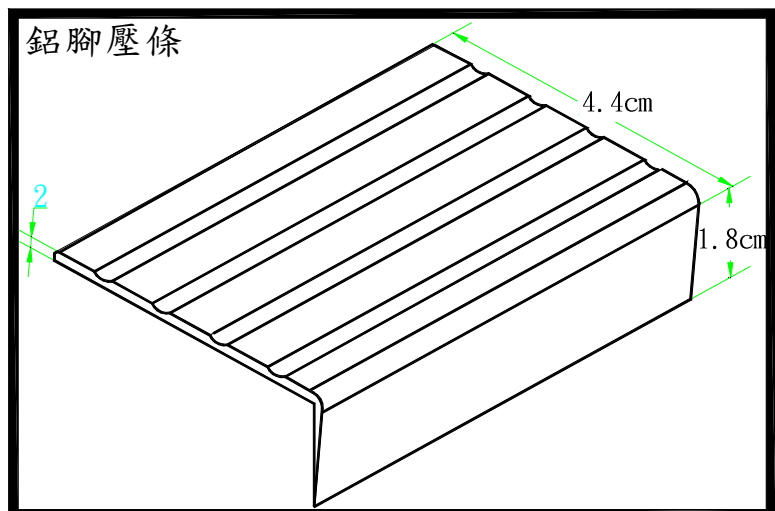
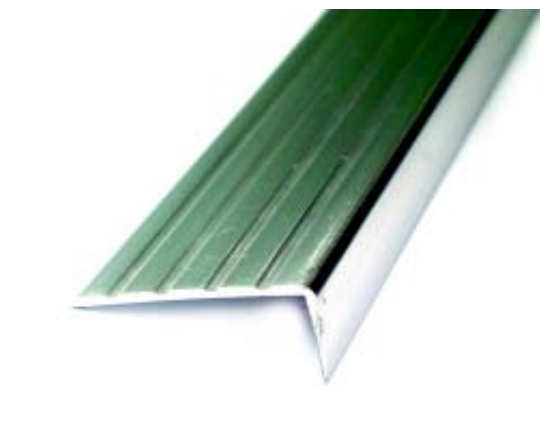

- B3051 鋁腳壓條薄鋁腳壓條 4.4x1.8x6M



B3063 T型角鋁 10mm\*10mm 6M  
B3064 T型角鋁 B 6.5MM\*6.5MM 6M

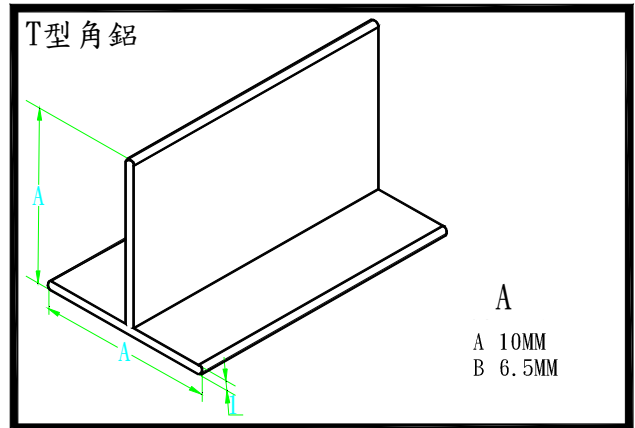

B3072 鋁壁板 5M

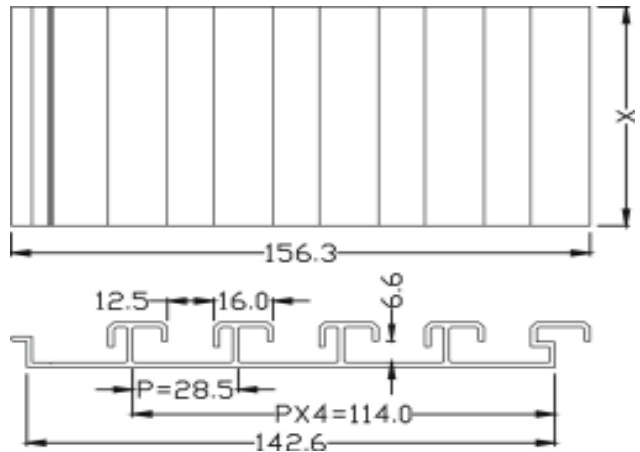

### 鋁壁板結構

如有過重或過長時，請塗上樹脂及AB膠，同時鎖上螺絲。

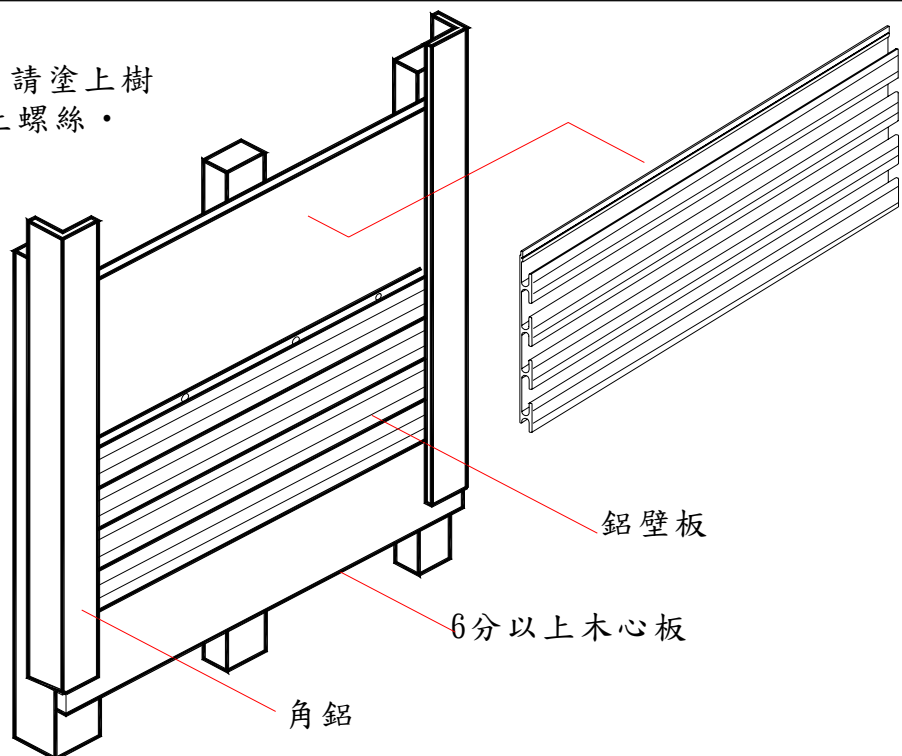



專利號碼：台灣 M242108  
日本 3099639  
中國 ZL03209647. X



B3076 專利展示塑膠壓修隔板

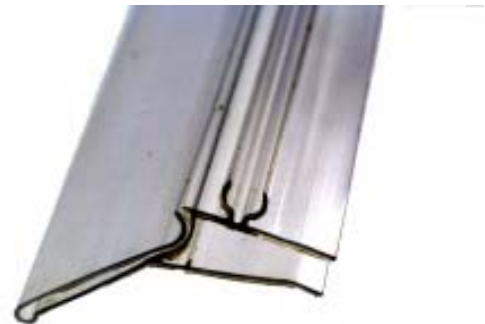

B3077 專利展示塑膠壓修隔板 - 壓條 8 尺  
B3078 專利展示塑膠壓修隔板 - 壓條 9 尺  
B3079 專利展示塑膠壓修隔板 - 壓條 12 尺



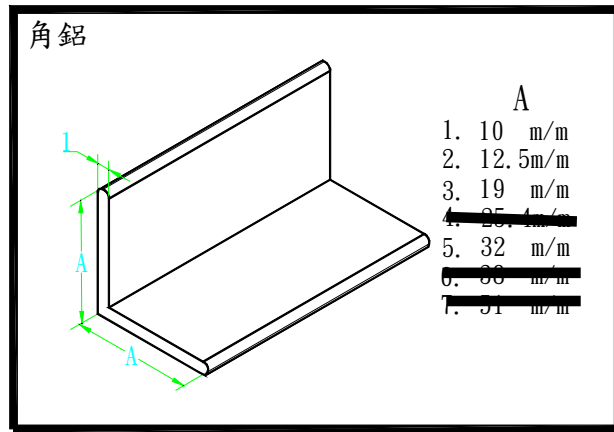
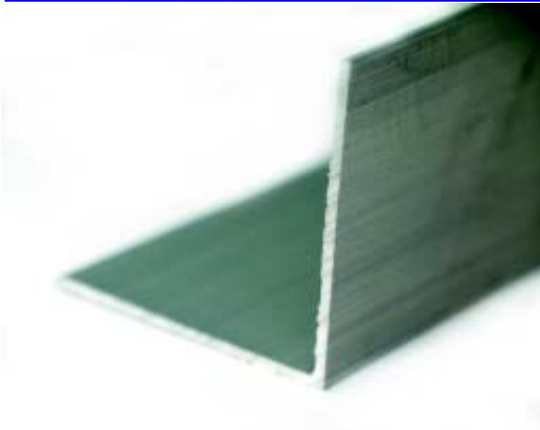

- B3011 3分角鋁
- B3012 4分角鋁
- B3013 6分角鋁
- B3015 1.1/4英吋角鋁

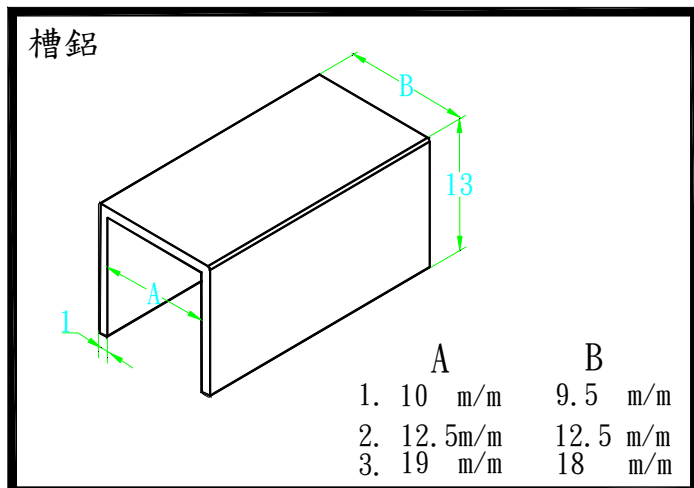

- B3031 3分槽鋁
- B3032 4分槽鋁
- B3033 6分槽鋁

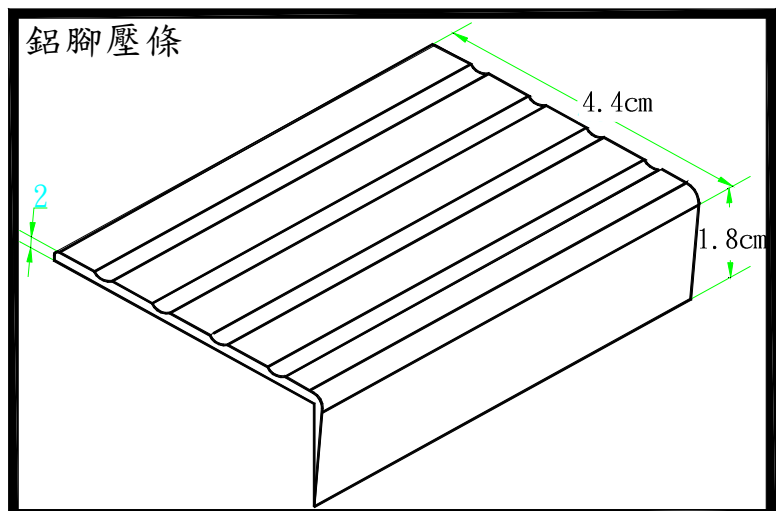
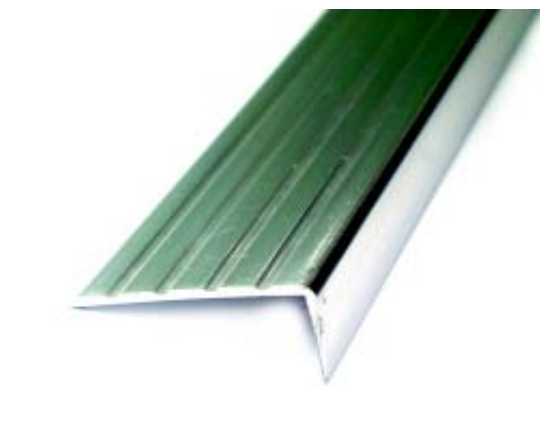

- B3051 鋁腳壓條薄鋁腳壓條 4.4x1.8x6M



B3063 T型角鋁 10mm\*10mm 6M  
B3064 T型角鋁 B 6.5MM\*6.5MM 6M

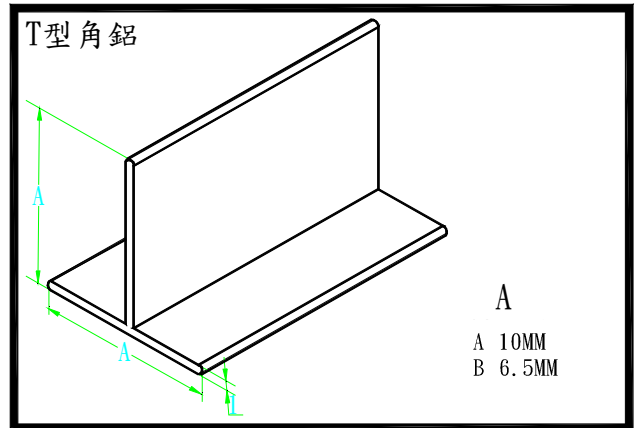

B3072 鋁壁板 5M

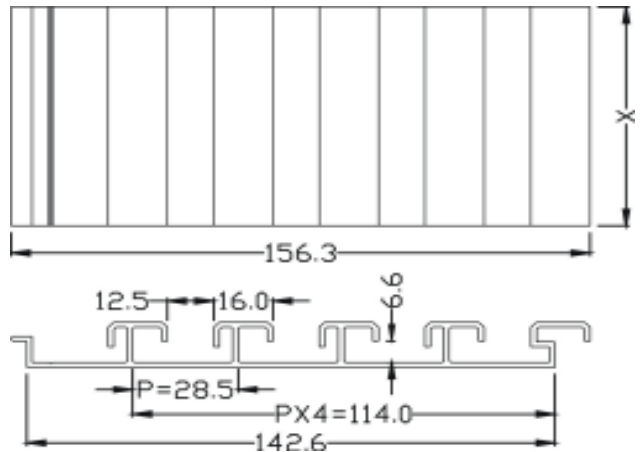

### 鋁壁板結構

如有過重或過長時，請塗上樹脂及AB膠，同時鎖上螺絲。

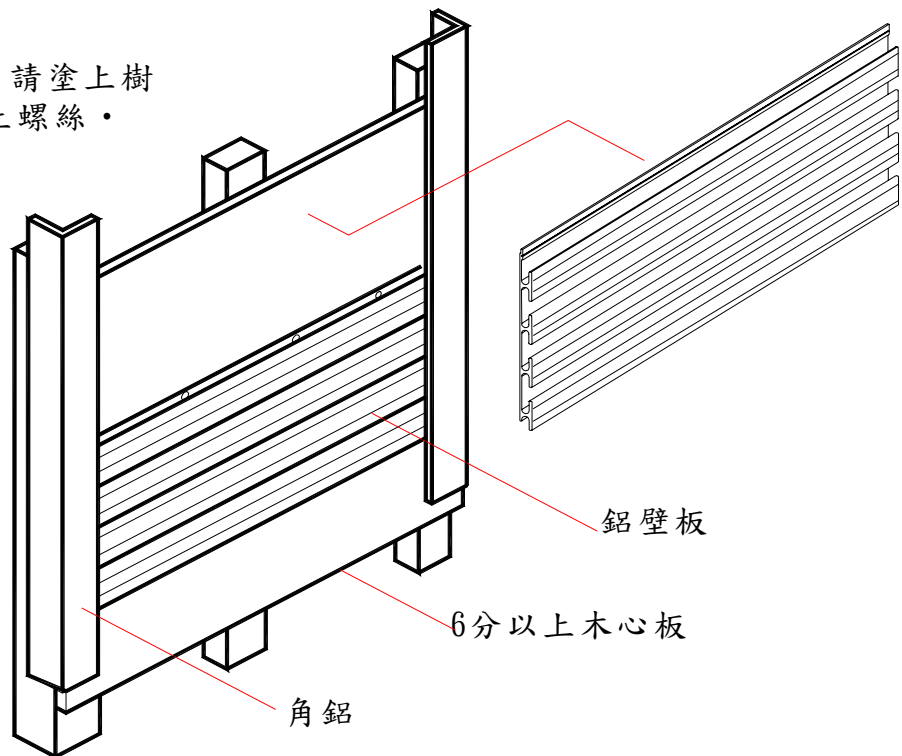



專利號碼：台灣 M242108  
日本 3099639  
中國 ZL03209647. X



B3076 專利展示塑膠壓修隔板

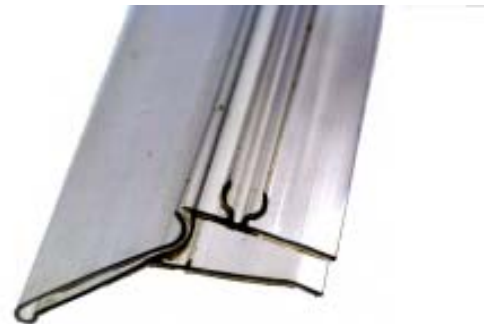

B3077 專利展示塑膠壓修隔板 - 壓條 8 尺  
B3078 專利展示塑膠壓修隔板 - 壓條 9 尺  
B3079 專利展示塑膠壓修隔板 - 壓條 12 尺





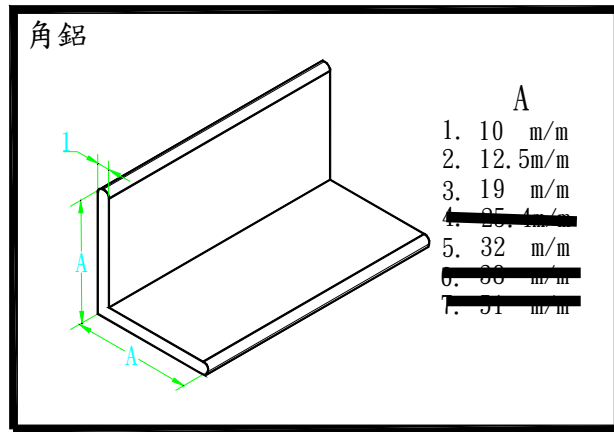
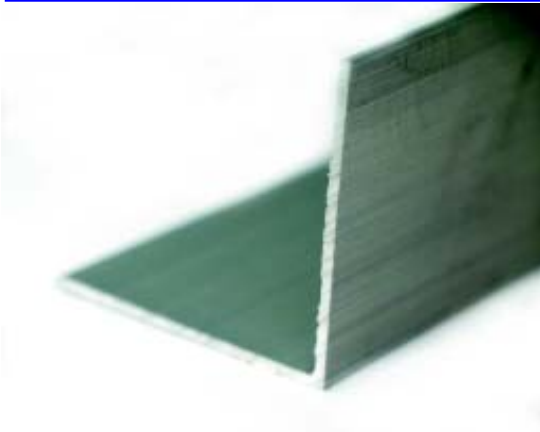

- B3011 3分角鋁
- B3012 4分角鋁
- B3013 6分角鋁
- B3015 1.1/4英吋角鋁

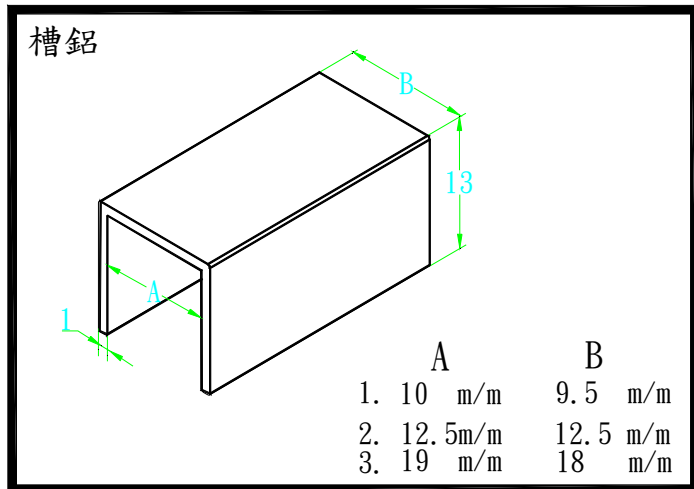
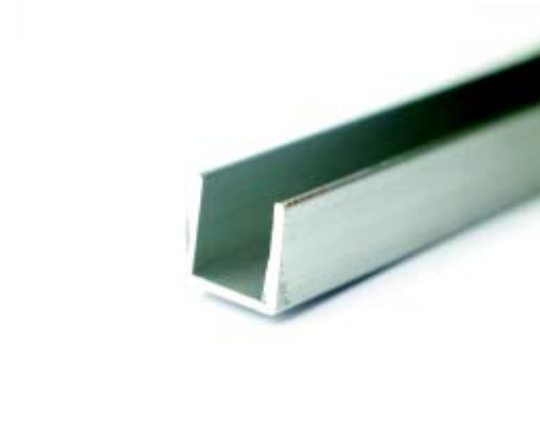

- B3031 3分槽鋁
- B3032 4分槽鋁
- B3033 6分槽鋁

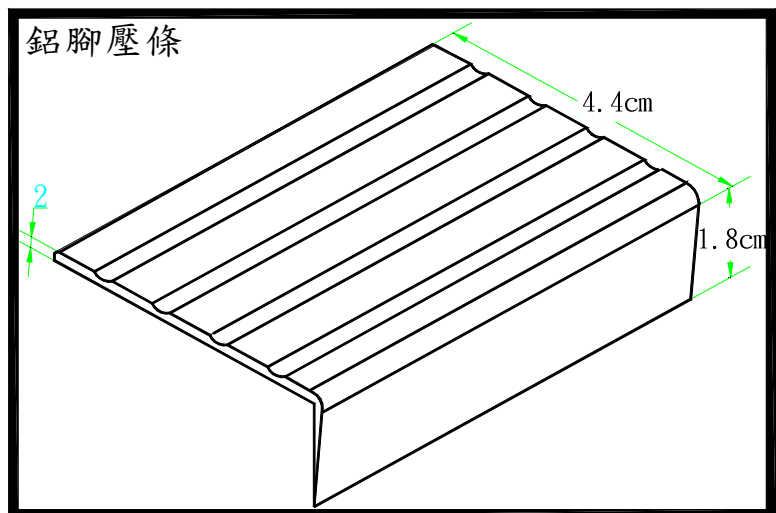
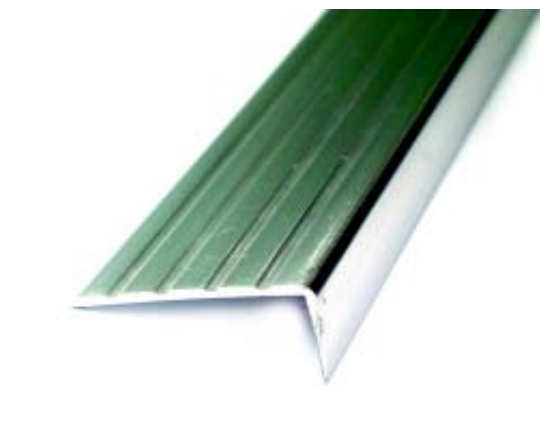

- B3051 鋁腳壓條薄鋁腳壓條 4.4x1.8x6M



B3063 T型角鋁 10mm\*10mm 6M  
B3064 T型角鋁 B 6.5MM\*6.5MM 6M

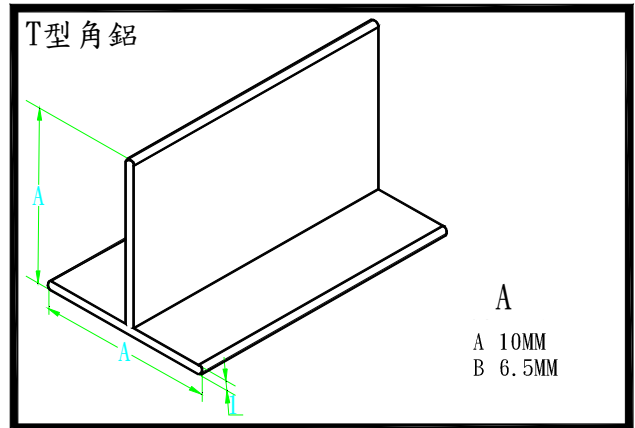

B3072 鋁壁板 5M

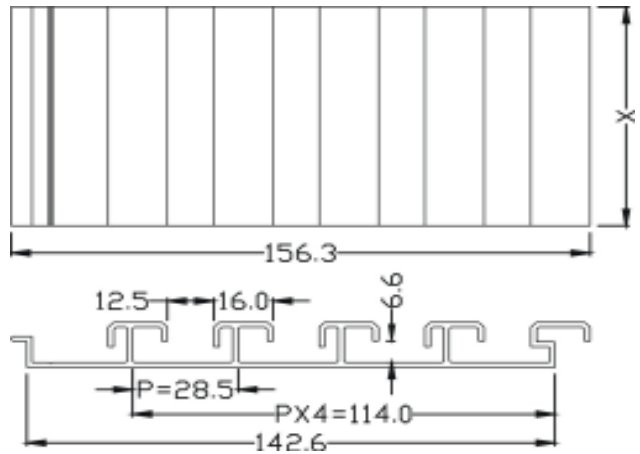

### 鋁壁板結構

如有過重或過長時，請塗上樹脂及AB膠，同時鎖上螺絲。

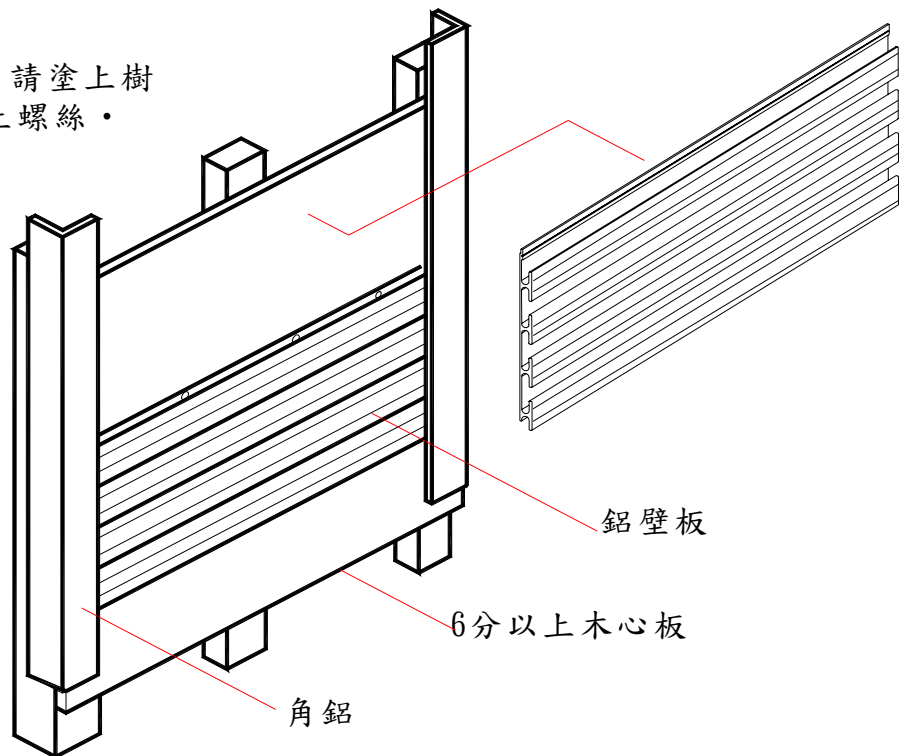



專利號碼：台灣 M242108  
日本 3099639  
中國 ZL03209647. X



B3076 專利展示塑膠壓修隔板

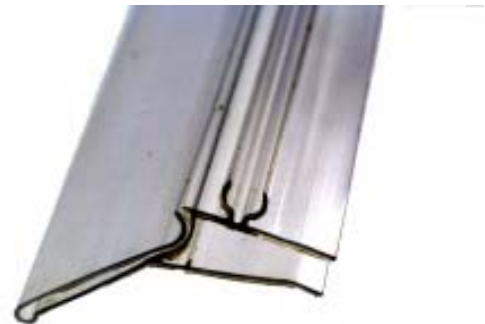

B3077 專利展示塑膠壓修隔板 - 壓條 8 尺  
B3078 專利展示塑膠壓修隔板 - 壓條 9 尺  
B3079 專利展示塑膠壓修隔板 - 壓條 12 尺



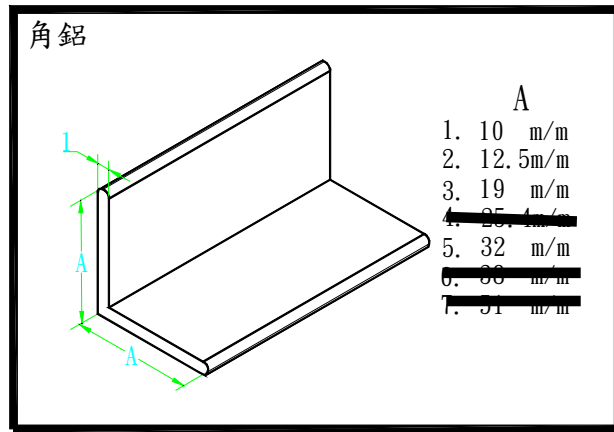
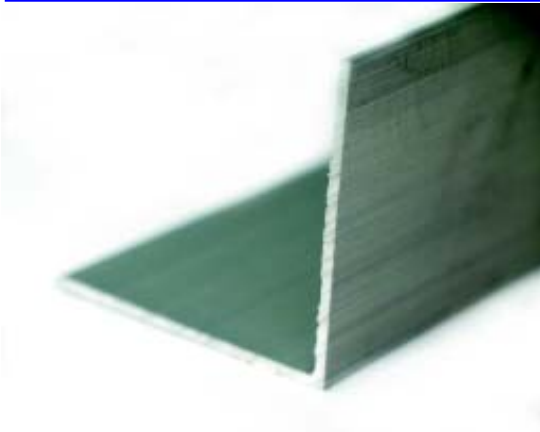

- B3011 3分角鋁
- B3012 4分角鋁
- B3013 6分角鋁
- B3015 1.1/4英吋角鋁

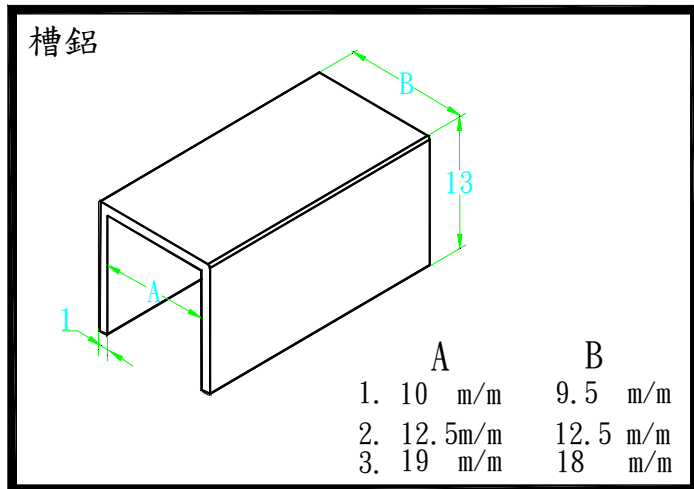
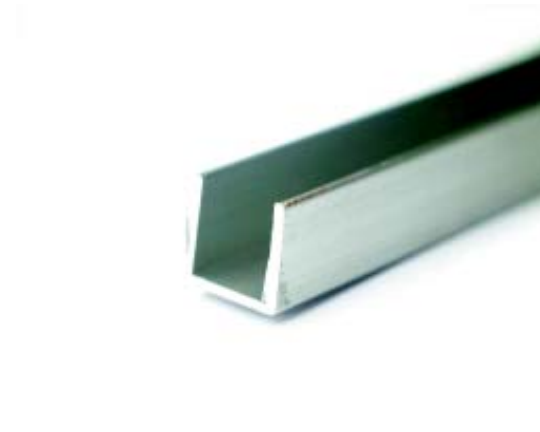

- B3031 3分槽鋁
- B3032 4分槽鋁
- B3033 6分槽鋁

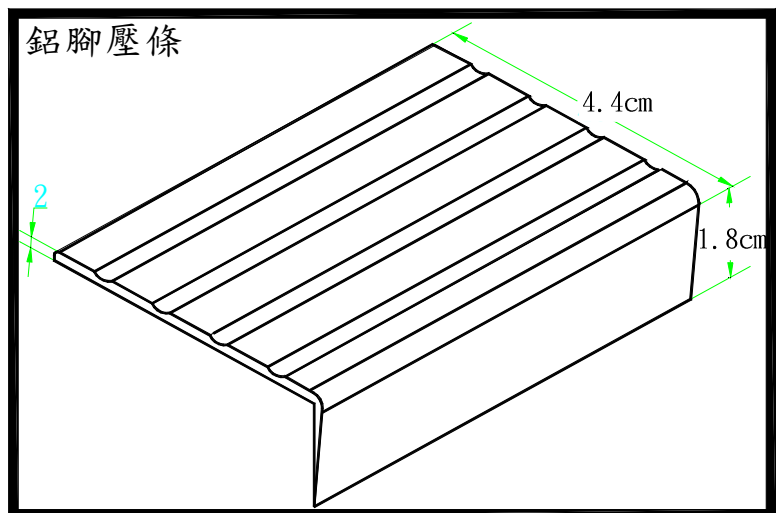
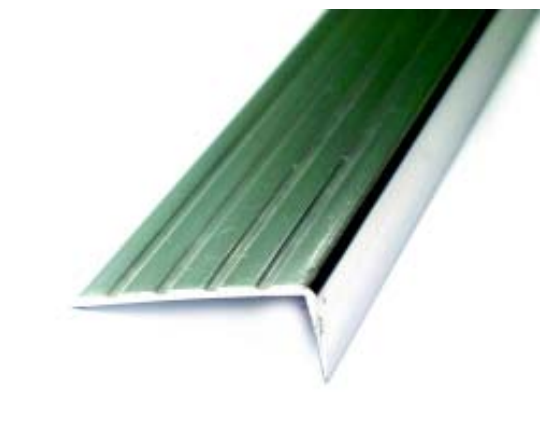

- B3051 鋁腳壓條薄鋁腳壓條 4.4x1.8x6M



B3063 T型角鋁 10mm\*10mm 6M  
B3064 T型角鋁 B 6.5MM\*6.5MM 6M

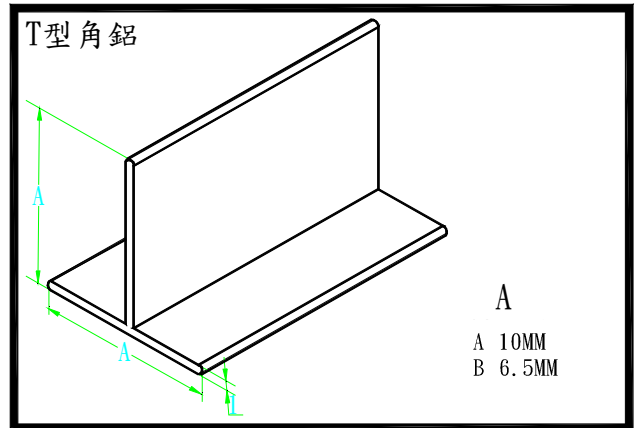

B3072 鋁壁板 5M

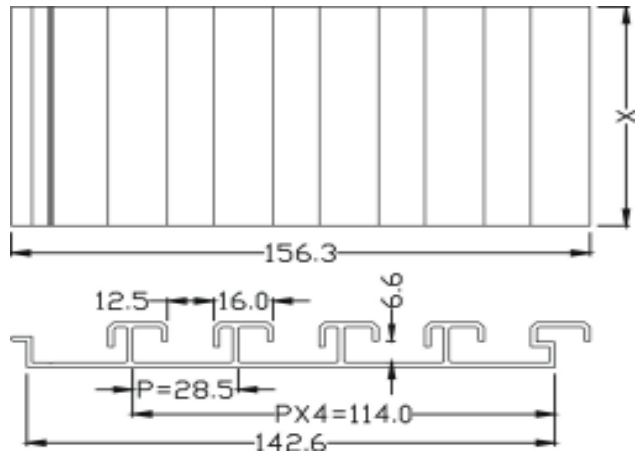

### 鋁壁板結構

如有過重或過長時，請塗上樹脂及AB膠，同時鎖上螺絲。

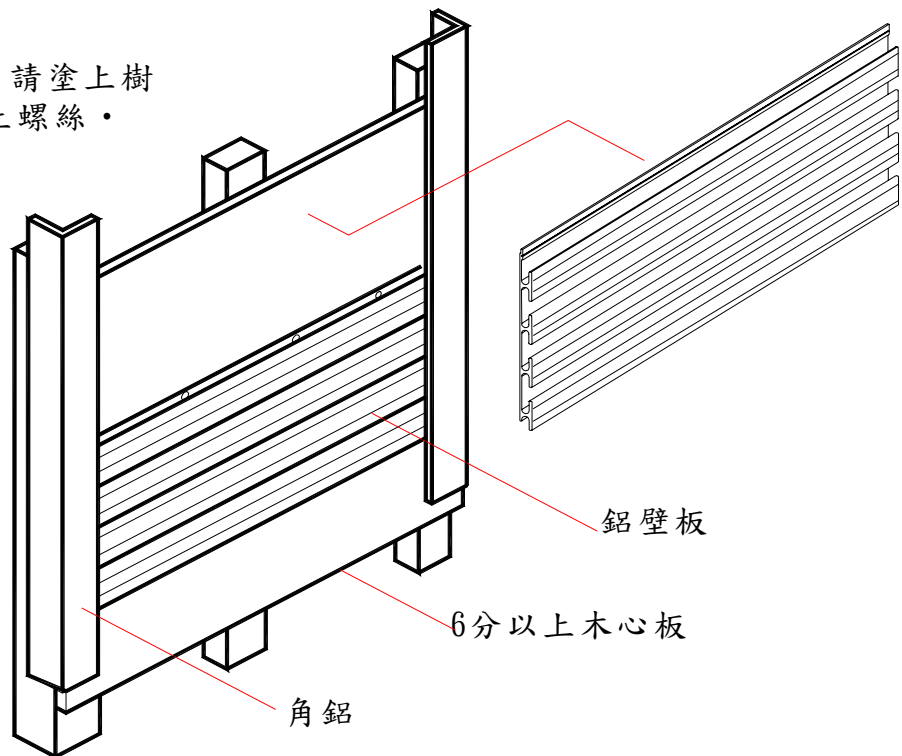



專利號碼：台灣 M242108  
日本 3099639  
中國 ZL03209647. X



B3076 專利展示塑膠壓修隔板

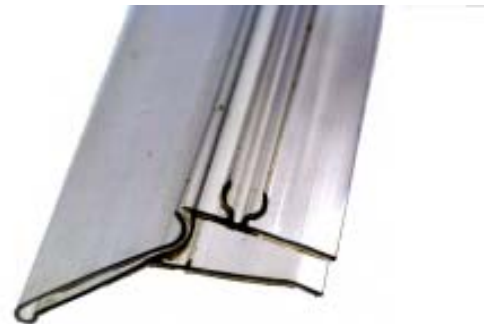

B3077 專利展示塑膠壓修隔板 - 壓條 8 尺  
B3078 專利展示塑膠壓修隔板 - 壓條 9 尺  
B3079 專利展示塑膠壓修隔板 - 壓條 12 尺





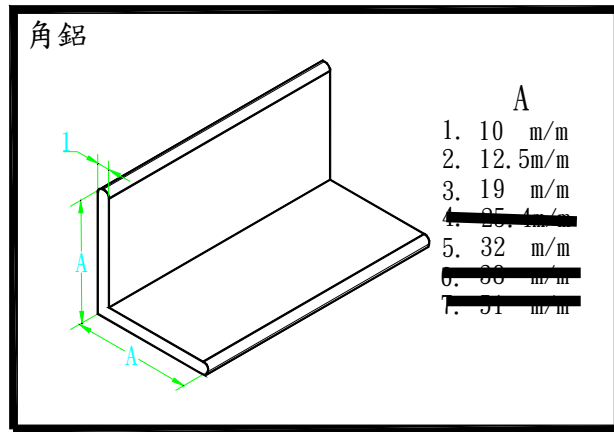
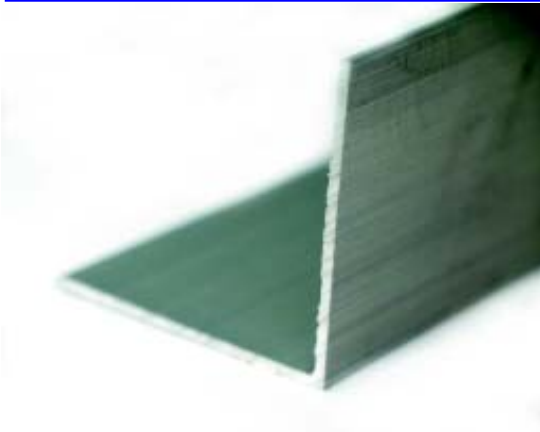

- B3011 3分角鋁
- B3012 4分角鋁
- B3013 6分角鋁
- B3015 1.1/4 英寸角鋁

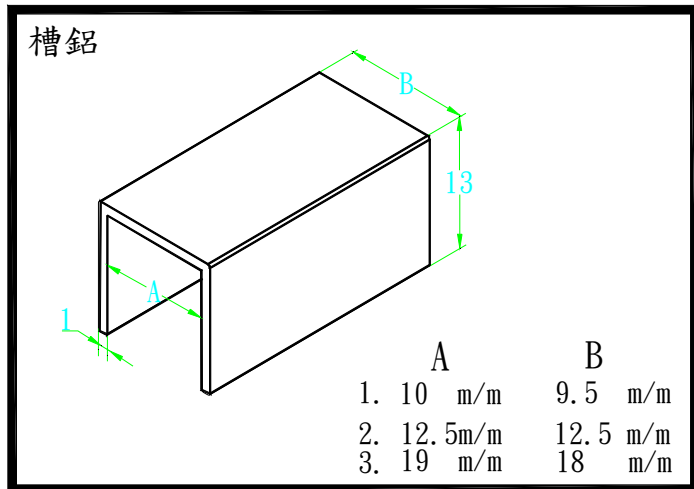
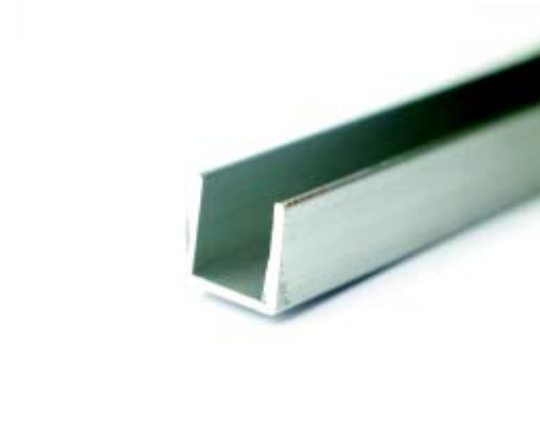

- B3031 3分槽鋁
- B3032 4分槽鋁
- B3033 6分槽鋁

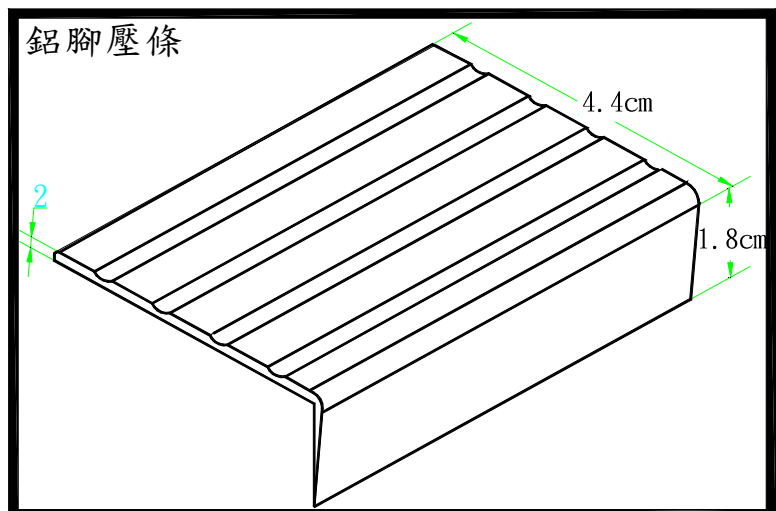
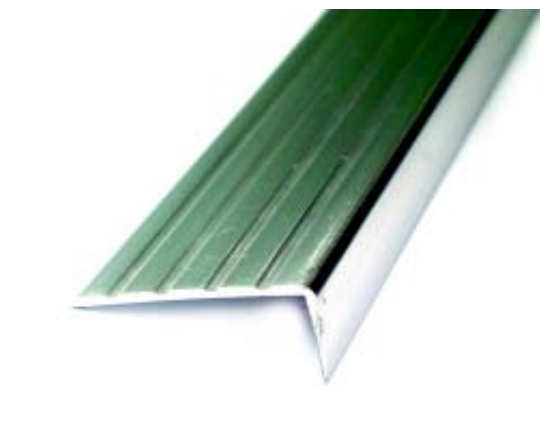

- B3051 鋁腳壓條薄鋁腳壓條 4.4x1.8x6M



B3063 T型角鋁 10mm\*10mm 6M  
B3064 T型角鋁 B 6.5MM\*6.5MM 6M

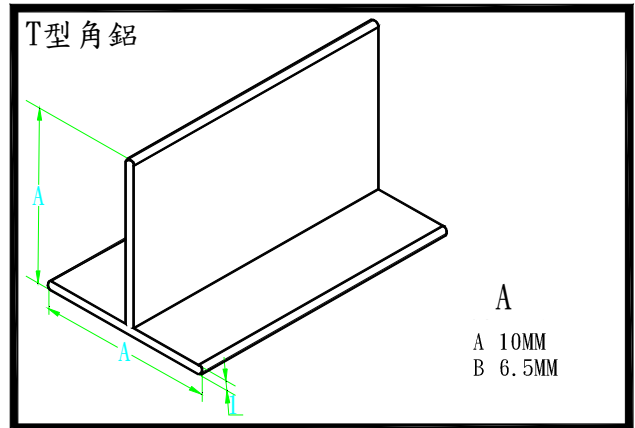

B3072 鋁壁板 5M

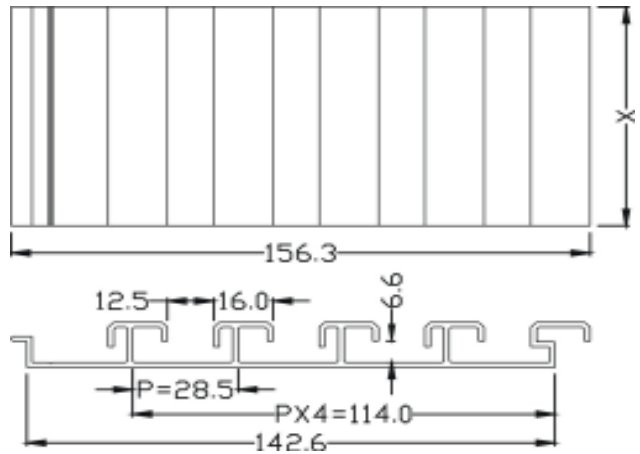

### 鋁壁板結構

如有過重或過長時，請塗上樹脂及AB膠，同時鎖上螺絲。

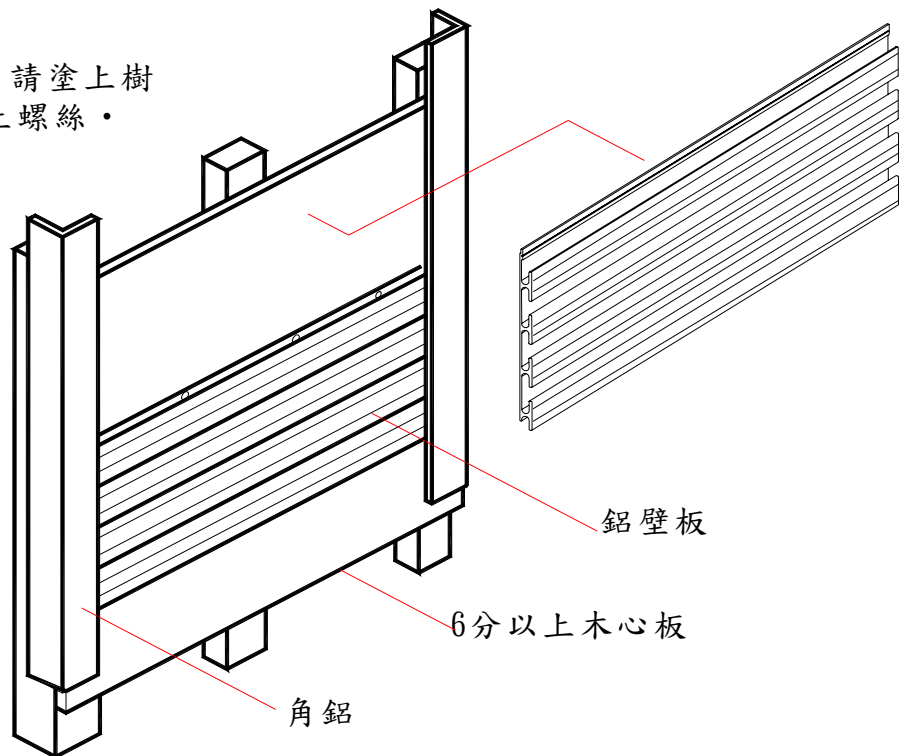



專利號碼：台灣 M242108  
日本 3099639  
中國 ZL03209647. X



B3076 專利展示塑膠壓修隔板

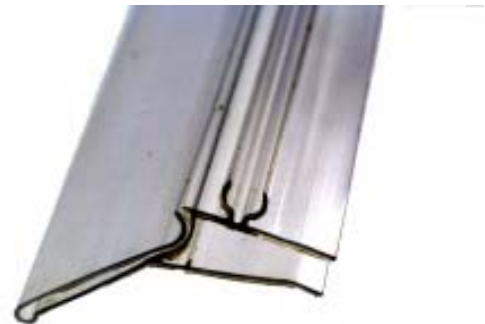

B3077 專利展示塑膠壓修隔板 - 壓條 8 尺  
B3078 專利展示塑膠壓修隔板 - 壓條 9 尺  
B3079 專利展示塑膠壓修隔板 - 壓條 12 尺



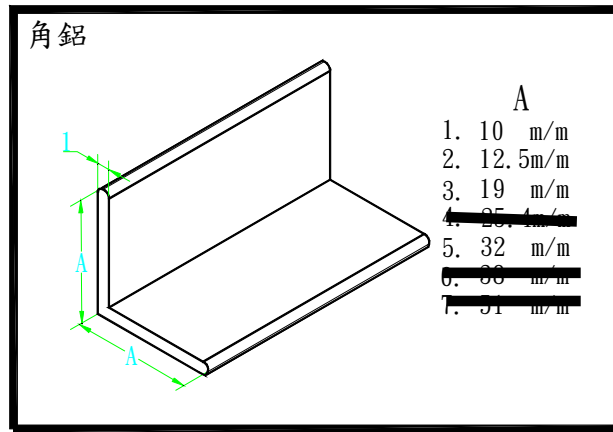
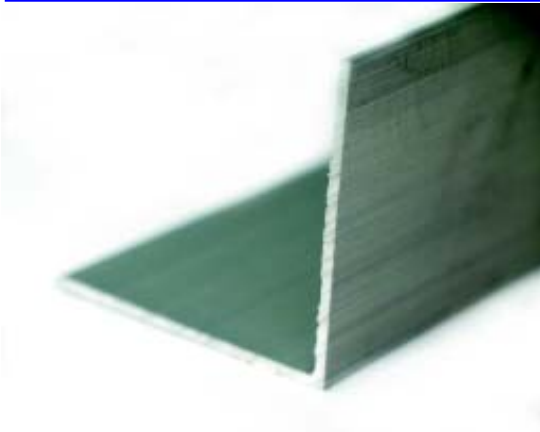

- B3011 3分角鋁
- B3012 4分角鋁
- B3013 6分角鋁
- B3015 1.1/4英寸角鋁

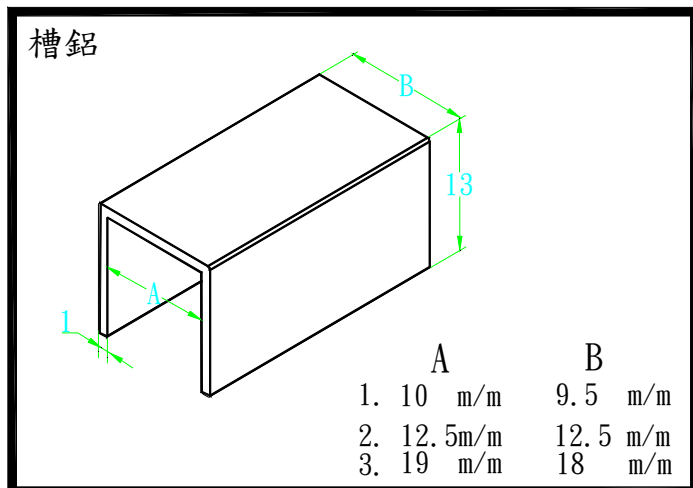
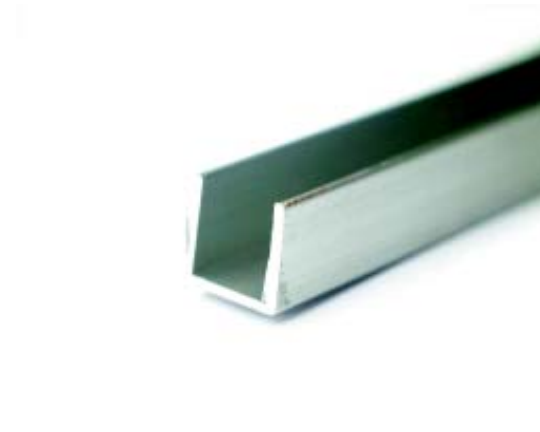

- B3031 3分槽鋁
- B3032 4分槽鋁
- B3033 6分槽鋁

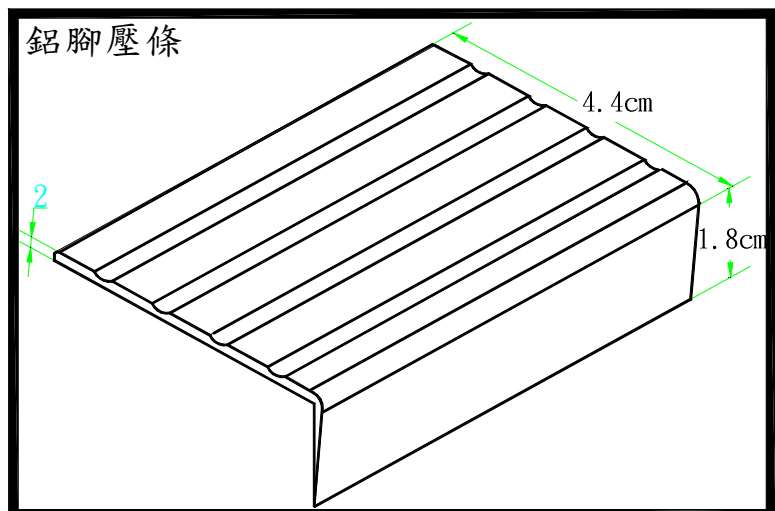
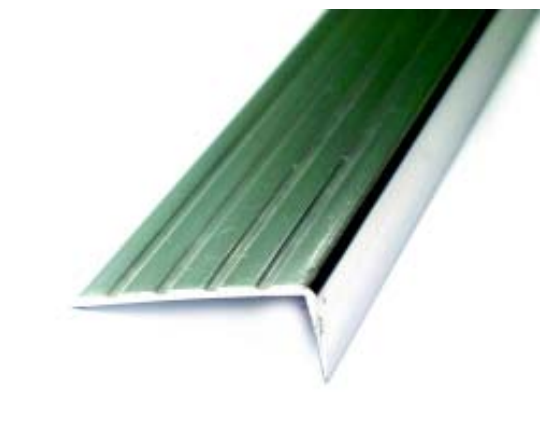

- B3051 鋁腳壓條薄鋁腳壓條 4.4x1.8x6M



B3063 T型角鋁 10mm\*10mm 6M  
B3064 T型角鋁 B 6.5MM\*6.5MM 6M

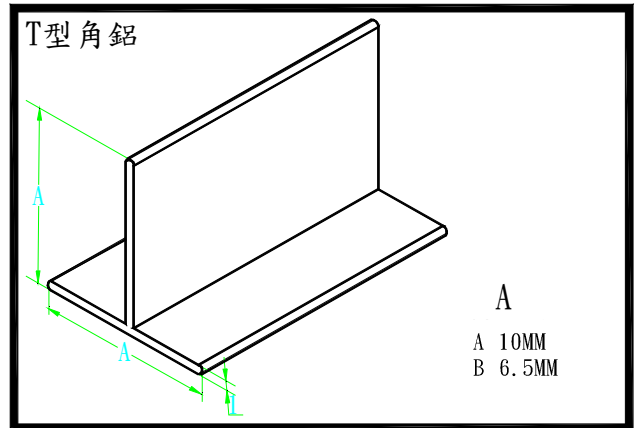

B3072 鋁壁板 5M

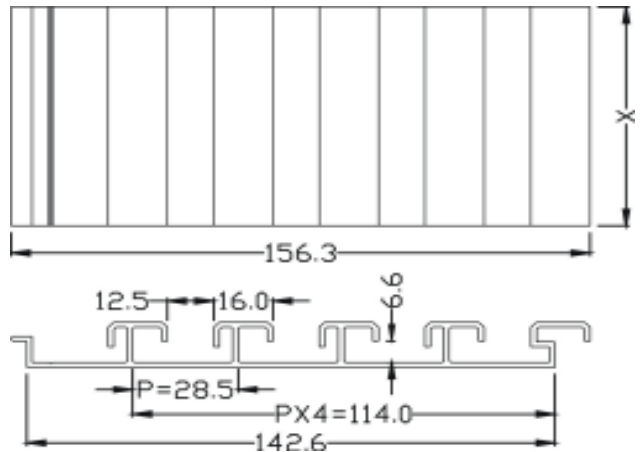

### 鋁壁板結構

如有過重或過長時，請塗上樹脂及AB膠，同時鎖上螺絲。

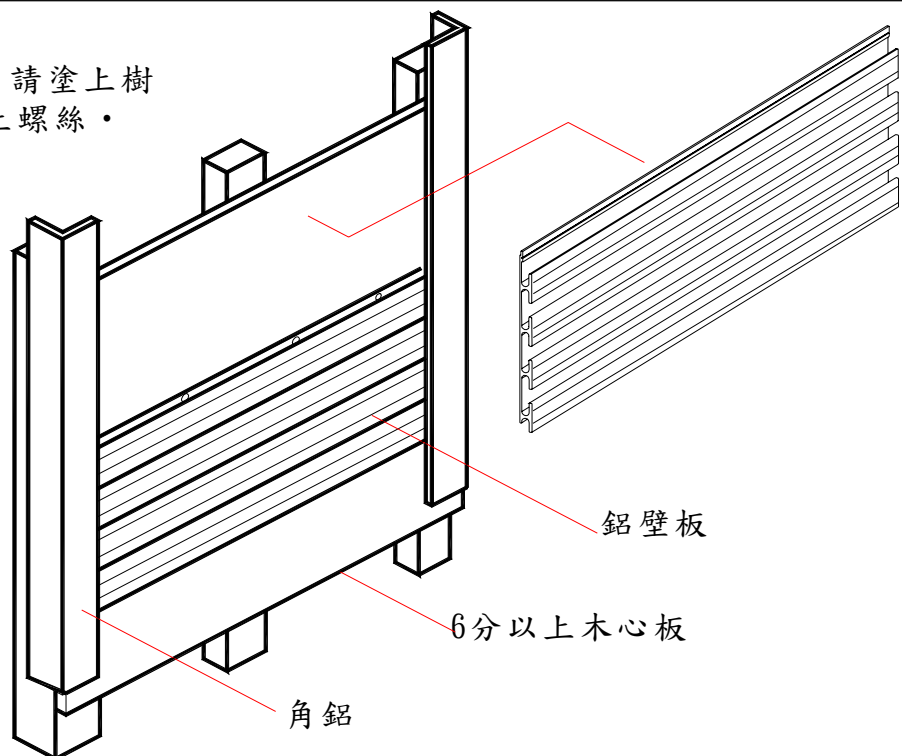



專利號碼：台灣 M242108  
日本 3099639  
中國 ZL03209647. X



B3076 專利展示塑膠壓修隔板

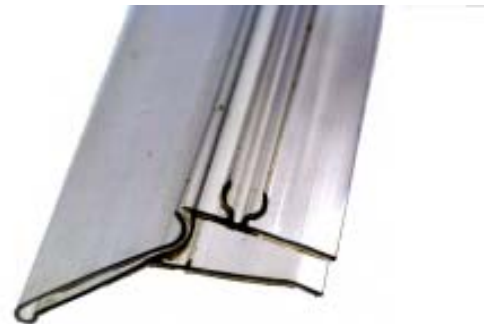

B3077 專利展示塑膠壓修隔板 - 壓條 8 尺  
B3078 專利展示塑膠壓修隔板 - 壓條 9 尺  
B3079 專利展示塑膠壓修隔板 - 壓條 12 尺





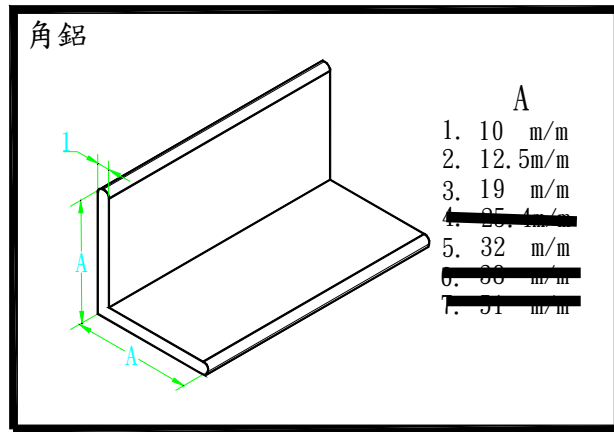
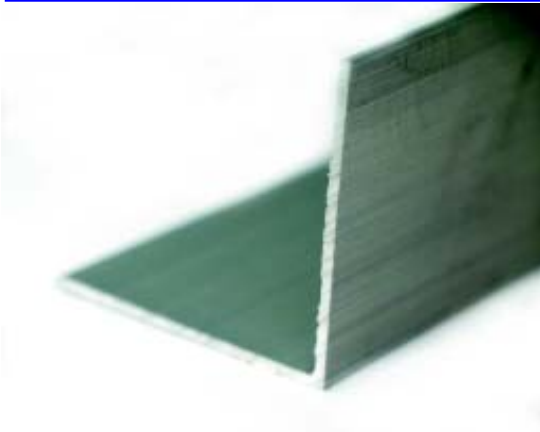

- B3011 3分角鋁
- B3012 4分角鋁
- B3013 6分角鋁
- B3015 1.1/4英吋角鋁

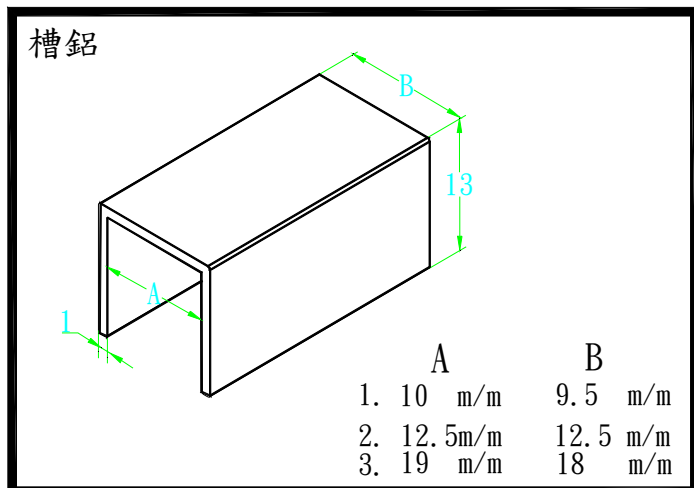
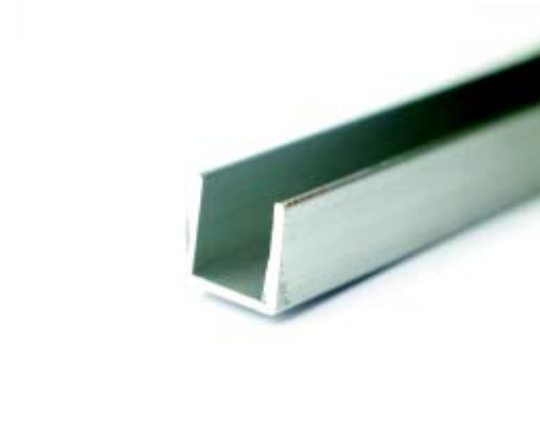

- B3031 3分槽鋁
- B3032 4分槽鋁
- B3033 6分槽鋁

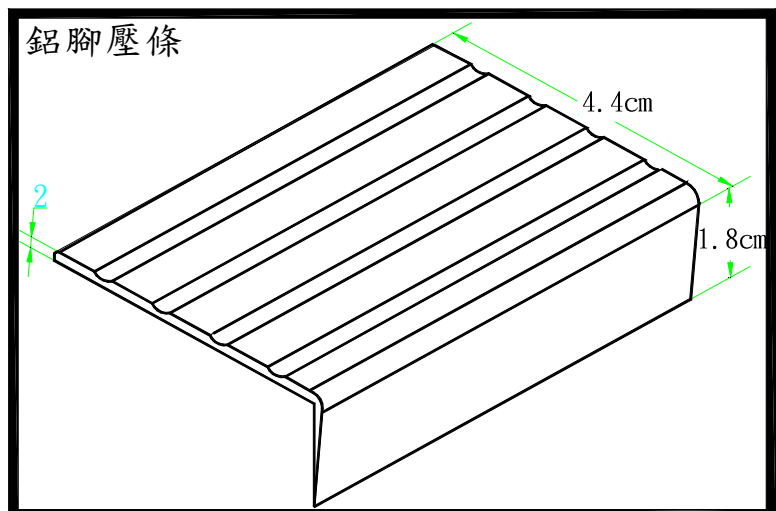
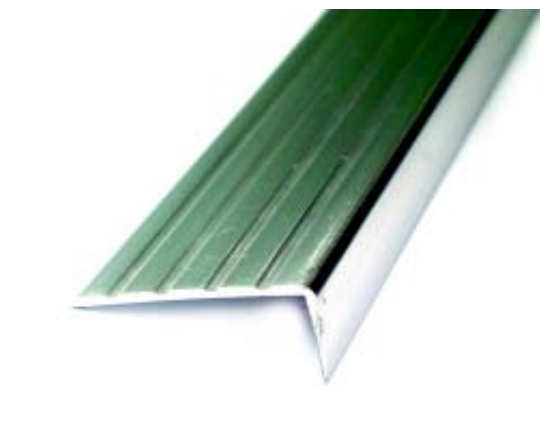

- B3051 鋁腳壓條薄鋁腳壓條 4.4x1.8x6M



B3063 T型角鋁 10mm\*10mm 6M  
B3064 T型角鋁 B 6.5MM\*6.5MM 6M

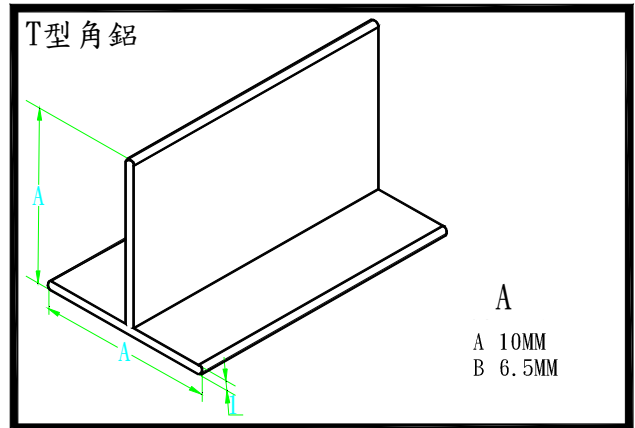

B3072 鋁壁板 5M

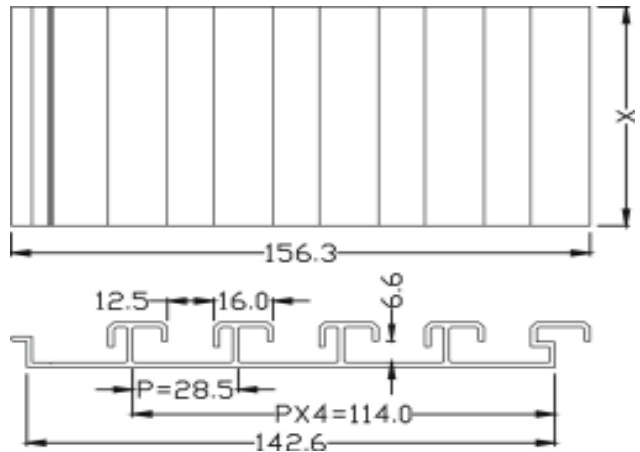

### 鋁壁板結構

如有過重或過長時，請塗上樹脂及AB膠，同時鎖上螺絲。

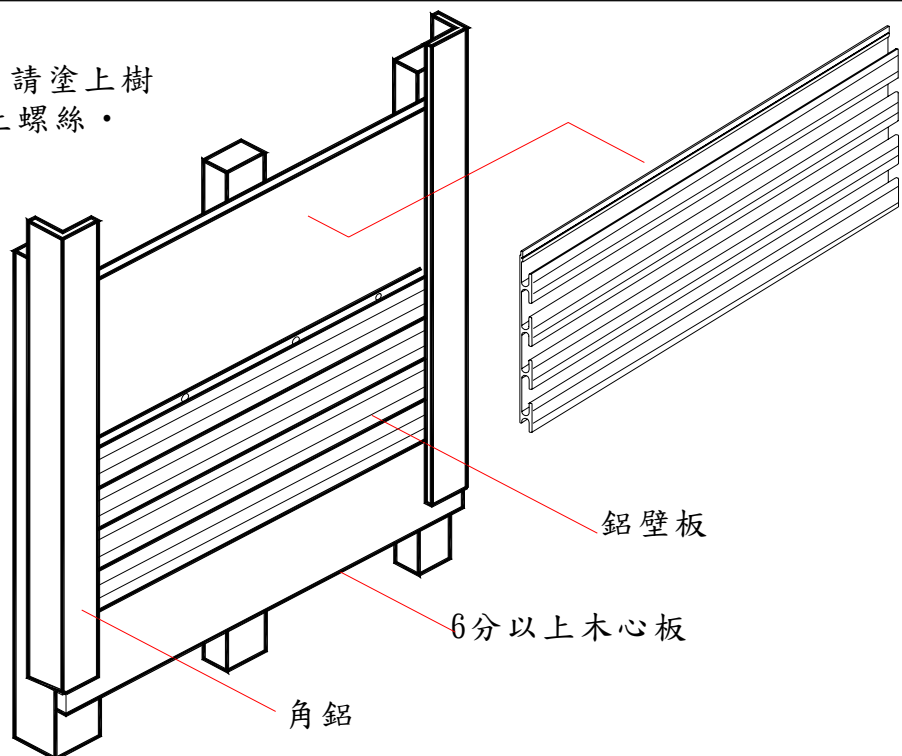



專利號碼：台灣 M242108  
日本 3099639  
中國 ZL03209647. X



B3076 專利展示塑膠壓修隔板

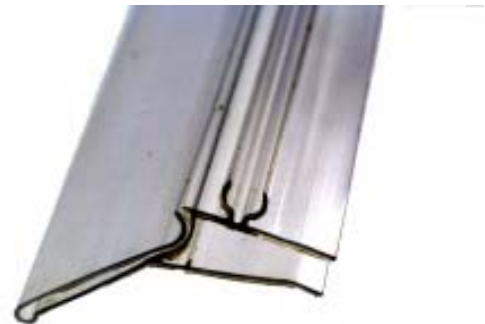

B3077 專利展示塑膠壓修隔板 - 壓條 8 尺  
B3078 專利展示塑膠壓修隔板 - 壓條 9 尺  
B3079 專利展示塑膠壓修隔板 - 壓條 12 尺



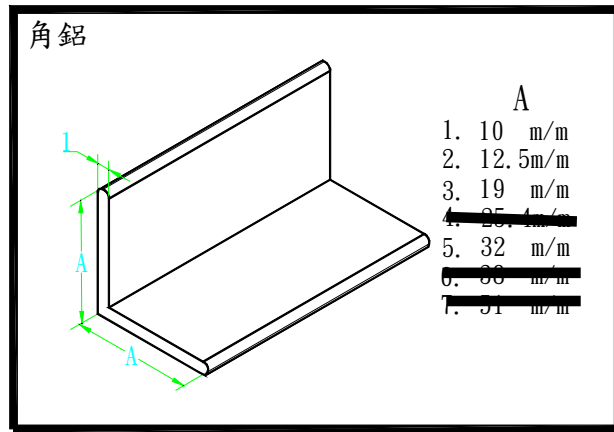
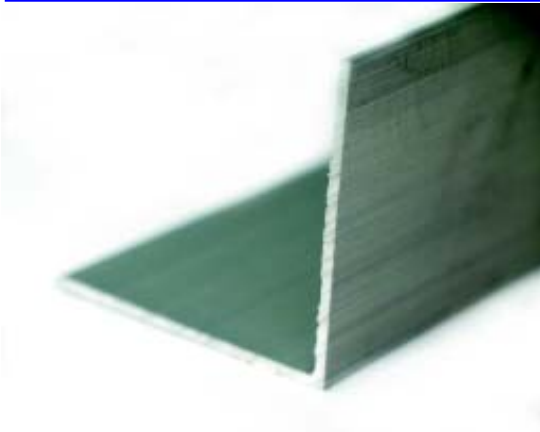

- B3011 3分角鋁
- B3012 4分角鋁
- B3013 6分角鋁
- B3015 1.1/4英吋角鋁

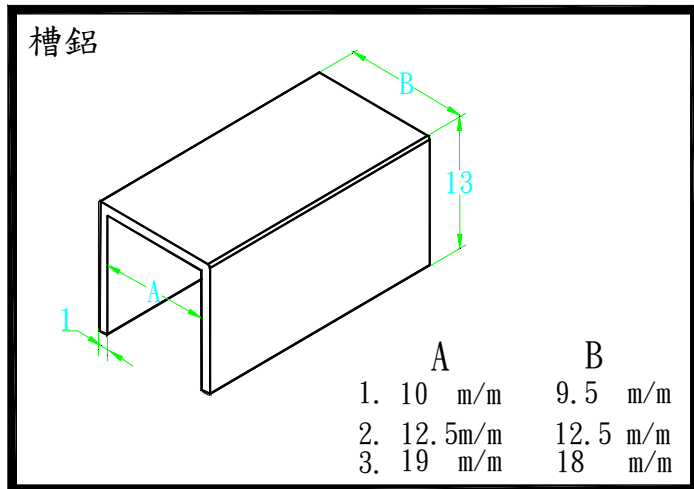

- B3031 3分槽鋁
- B3032 4分槽鋁
- B3033 6分槽鋁

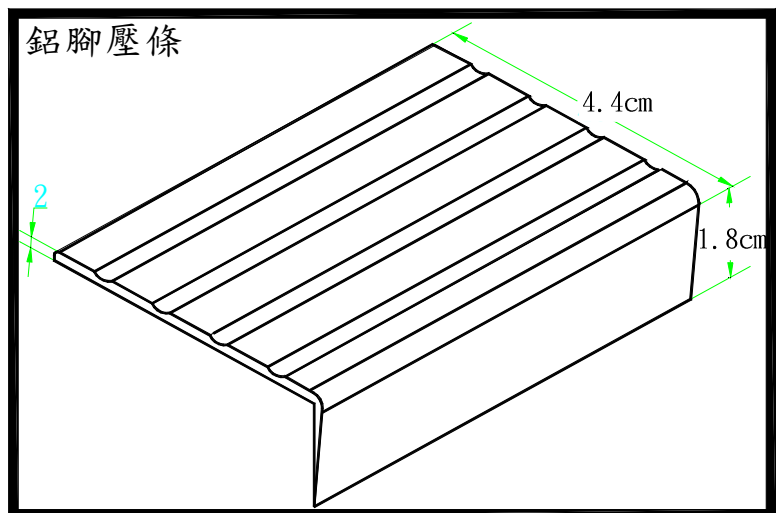
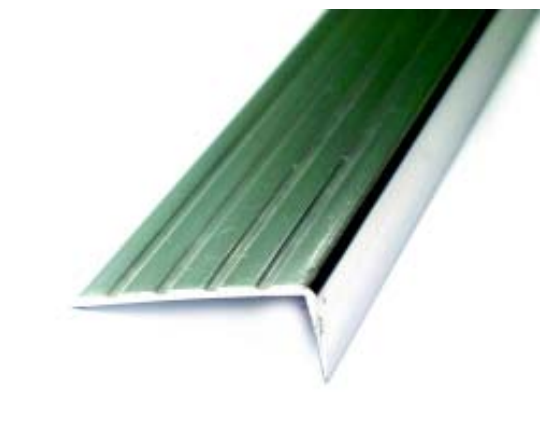

- B3051 鋁腳壓條薄鋁腳壓條 4.4x1.8x6M



B3063 T型角鋁 10mm\*10mm 6M  
B3064 T型角鋁 B 6.5MM\*6.5MM 6M

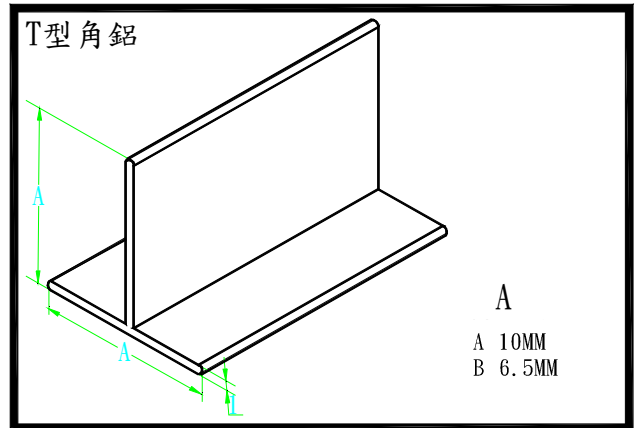

B3072 鋁壁板 5M

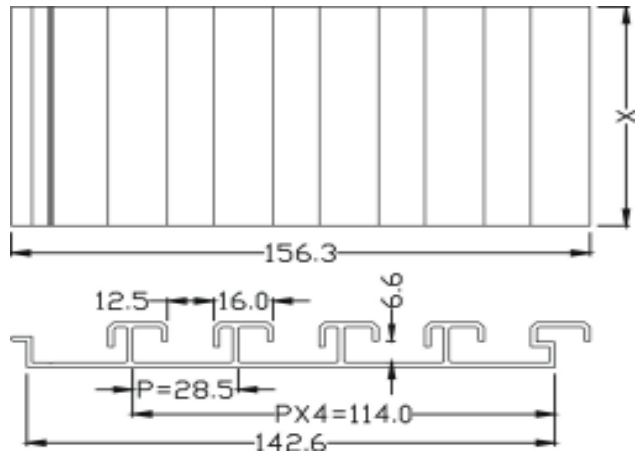

### 鋁壁板結構

如有過重或過長時，請塗上樹脂及AB膠，同時鎖上螺絲。

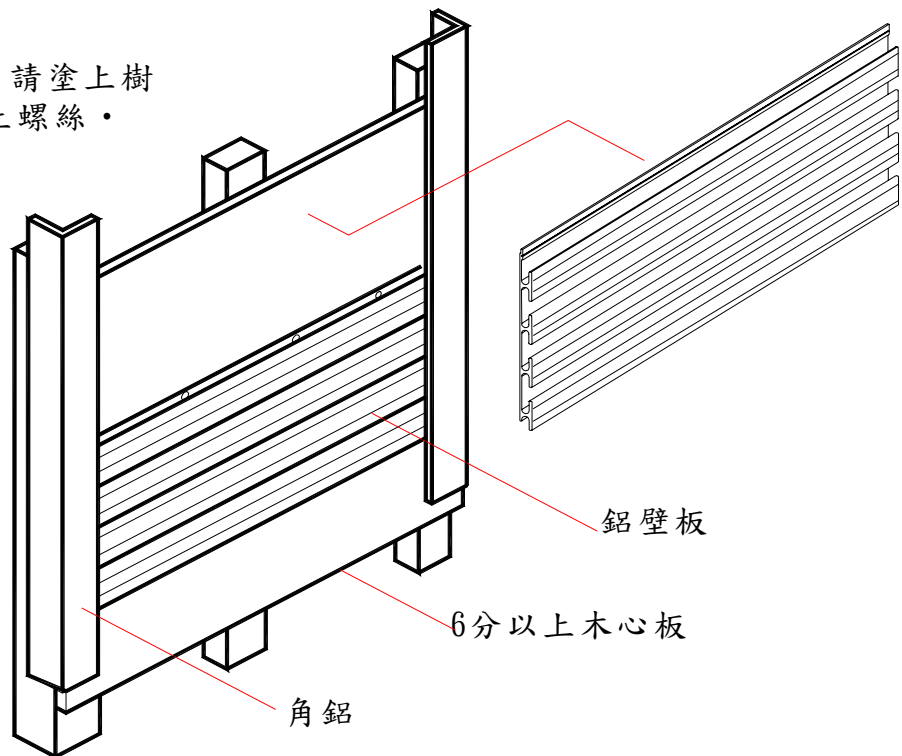



專利號碼：台灣 M242108  
日本 3099639  
中國 ZL03209647. X



B3076 專利展示塑膠壓修隔板

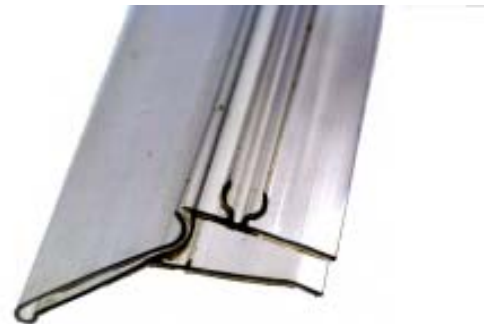

B3077 專利展示塑膠壓修隔板 - 壓條 8 尺  
B3078 專利展示塑膠壓修隔板 - 壓條 9 尺  
B3079 專利展示塑膠壓修隔板 - 壓條 12 尺





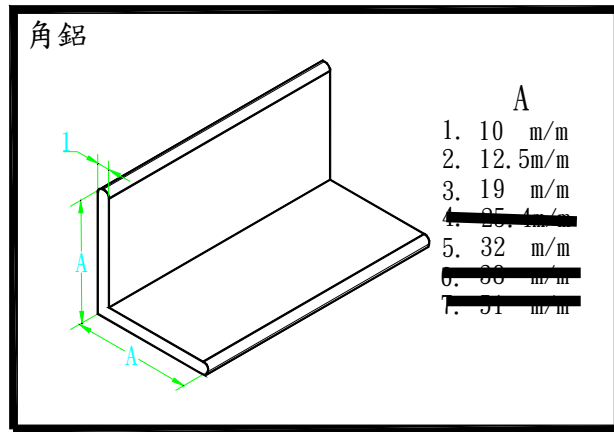
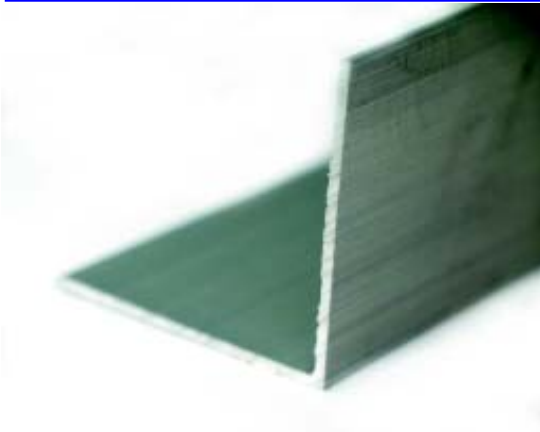

- B3011 3分角鋁
- B3012 4分角鋁
- B3013 6分角鋁
- B3015 1.1/4英吋角鋁

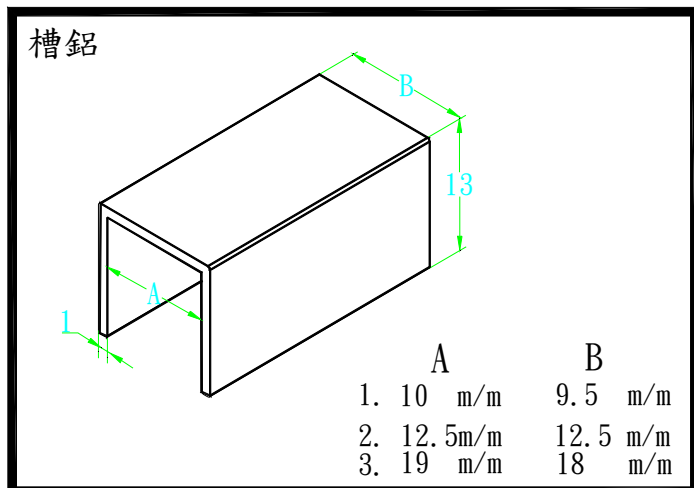
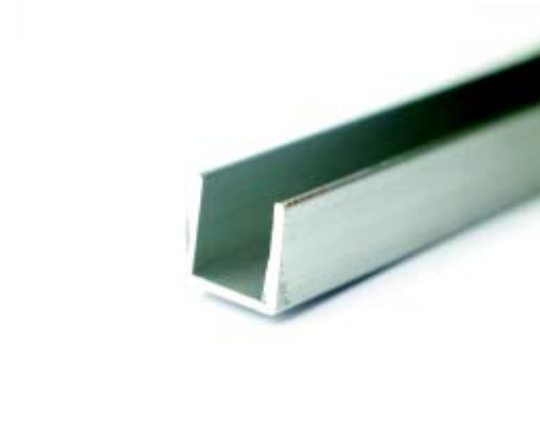

- B3031 3分槽鋁
- B3032 4分槽鋁
- B3033 6分槽鋁

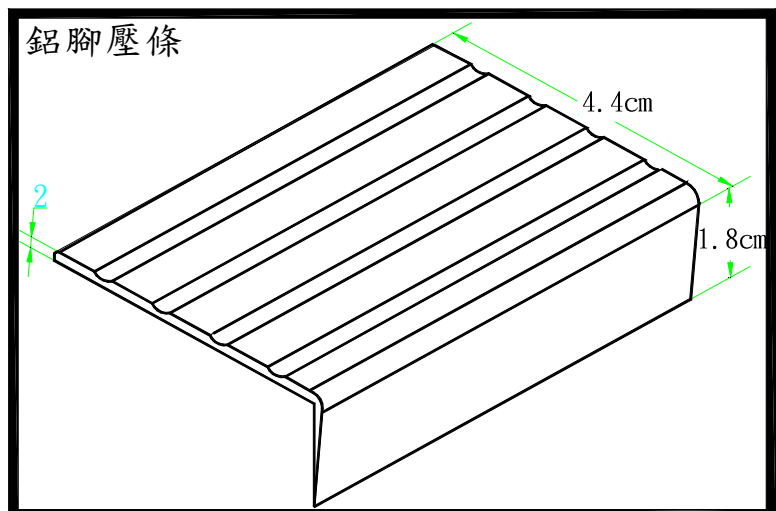
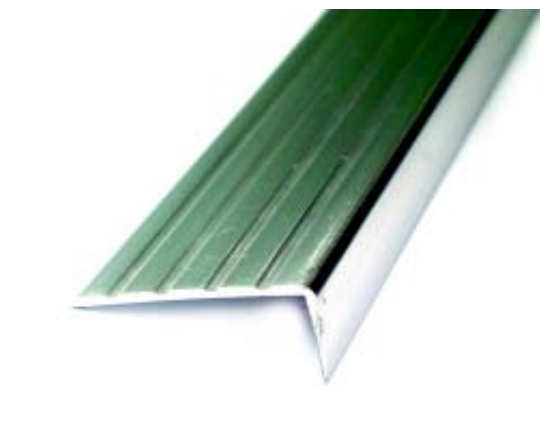

- B3051 鋁腳壓條薄鋁腳壓條 4.4x1.8x6M



B3063 T型角鋁 10mm\*10mm 6M  
B3064 T型角鋁 B 6.5MM\*6.5MM 6M

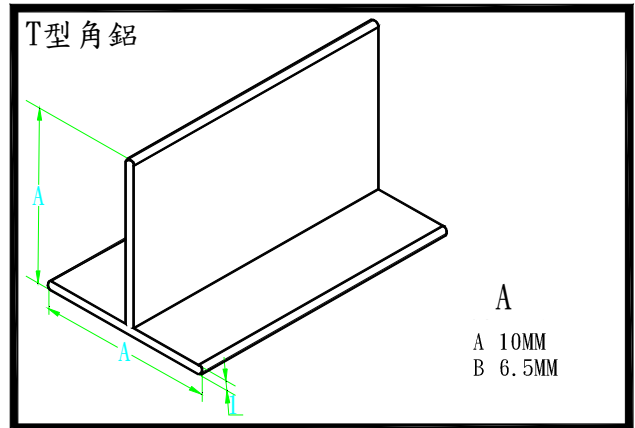

B3072 鋁壁板 5M

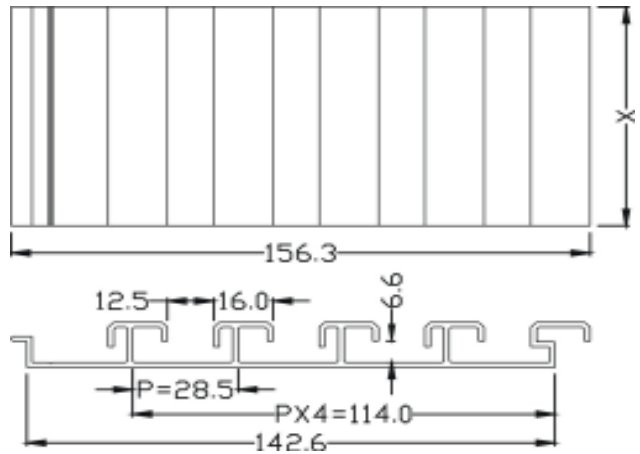

### 鋁壁板結構

如有過重或過長時，請塗上樹脂及AB膠，同時鎖上螺絲。

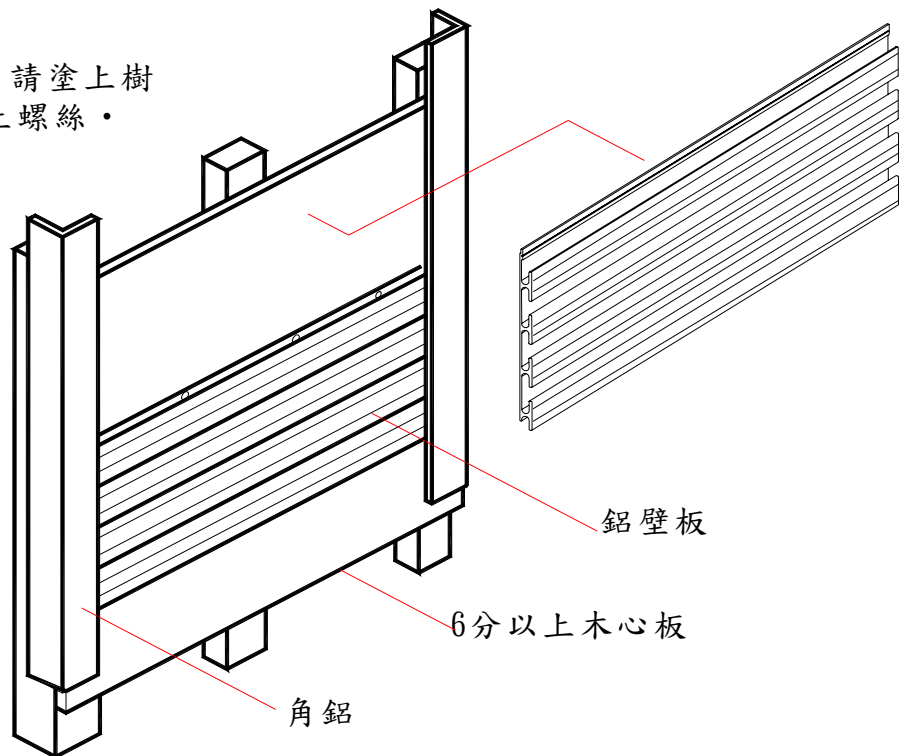



專利號碼：台灣 M242108  
日本 3099639  
中國 ZL03209647. X



B3076 專利展示塑膠壓修隔板

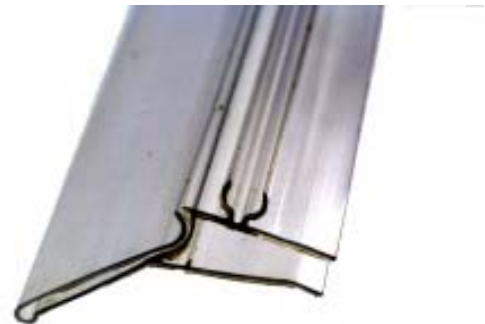

B3077 專利展示塑膠壓修隔板 - 壓條 8 尺  
B3078 專利展示塑膠壓修隔板 - 壓條 9 尺  
B3079 專利展示塑膠壓修隔板 - 壓條 12 尺



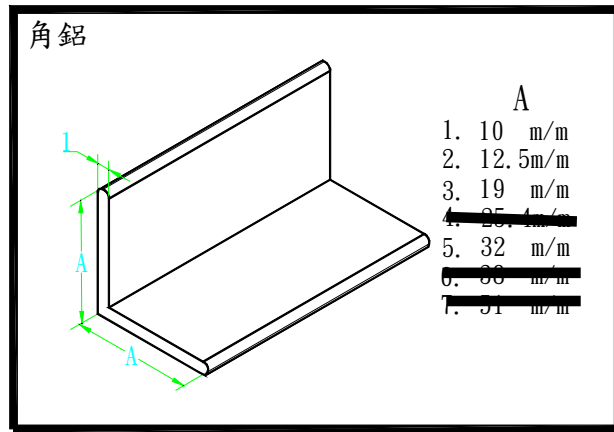
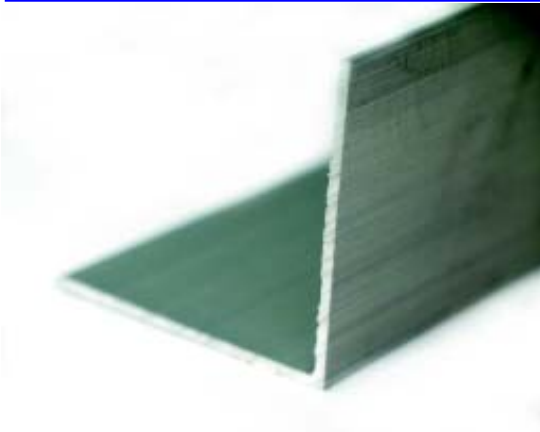

- B3011 3分角鋁
- B3012 4分角鋁
- B3013 6分角鋁
- B3015 1.1/4英吋角鋁

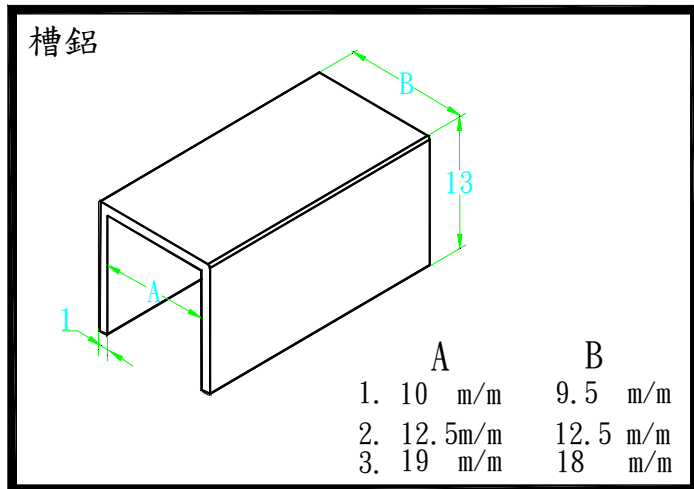

- B3031 3分槽鋁
- B3032 4分槽鋁
- B3033 6分槽鋁

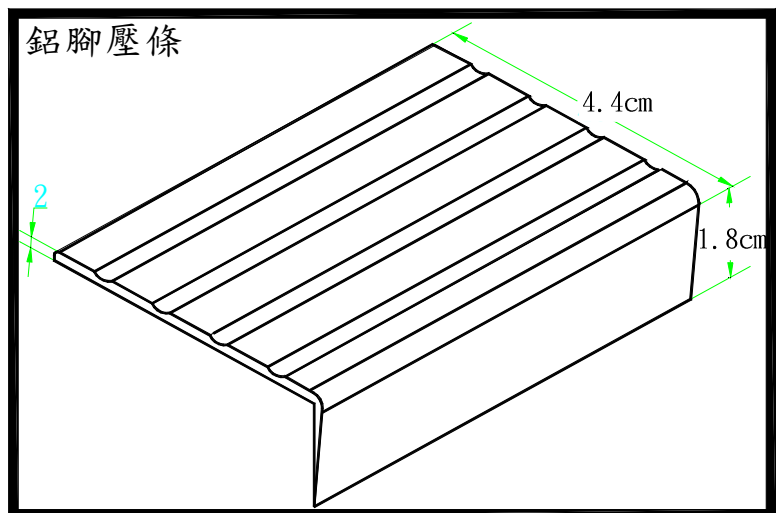
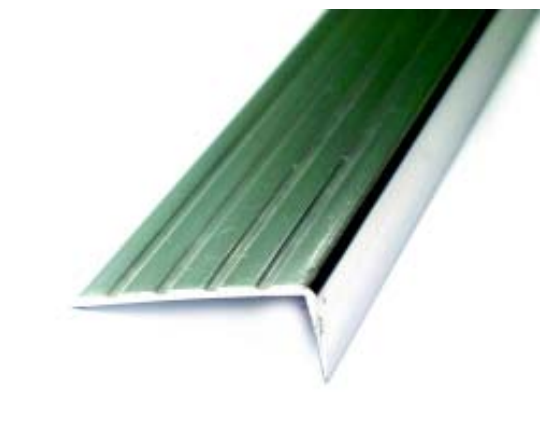

- B3051 鋁腳壓條薄鋁腳壓條 4.4x1.8x6M



B3063 T型角鋁 10mm\*10mm 6M  
B3064 T型角鋁 B 6.5MM\*6.5MM 6M

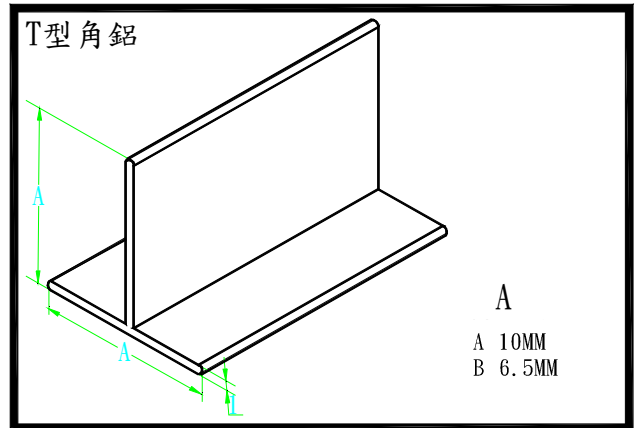

B3072 鋁壁板 5M

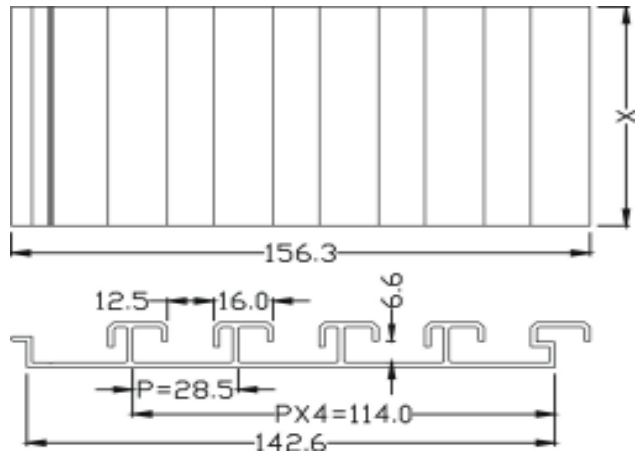

### 鋁壁板結構

如有過重或過長時，請塗上樹脂及AB膠，同時鎖上螺絲。

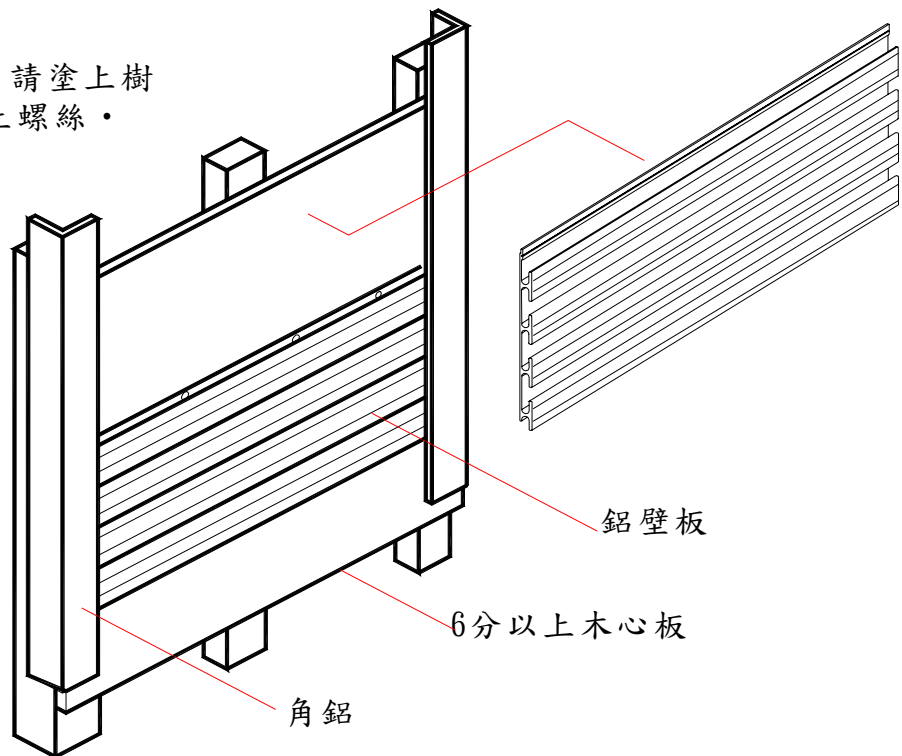



專利號碼：台灣 M242108  
日本 3099639  
中國 ZL03209647. X



B3076 專利展示塑膠壓修隔板

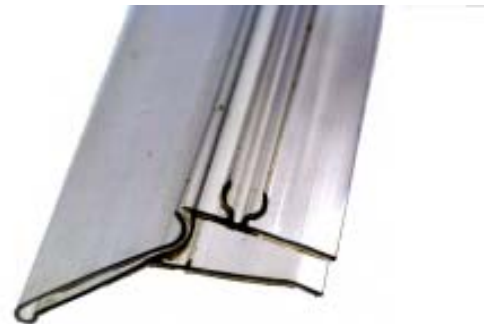

B3077 專利展示塑膠壓修隔板 - 壓條 8 尺  
B3078 專利展示塑膠壓修隔板 - 壓條 9 尺  
B3079 專利展示塑膠壓修隔板 - 壓條 12 尺





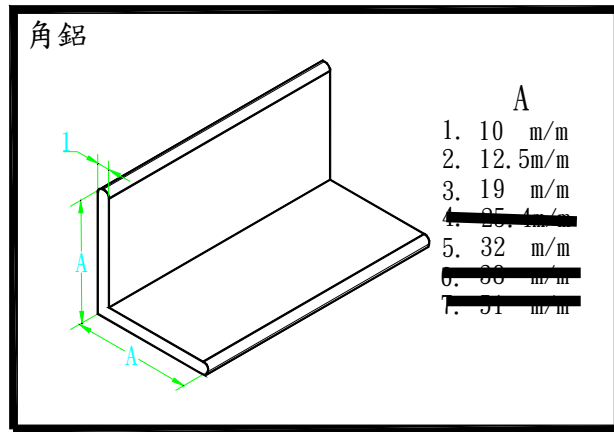
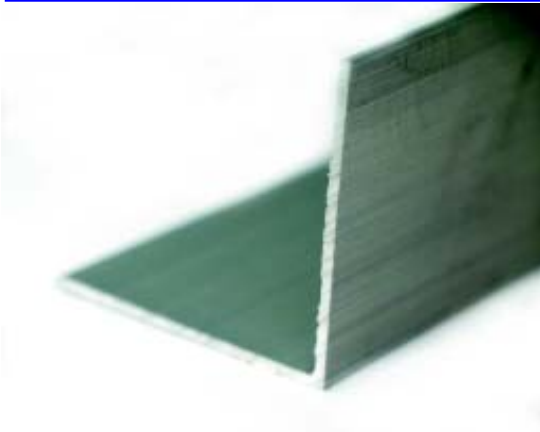

- B3011 3分角鋁
- B3012 4分角鋁
- B3013 6分角鋁
- B3015 1.1/4英吋角鋁

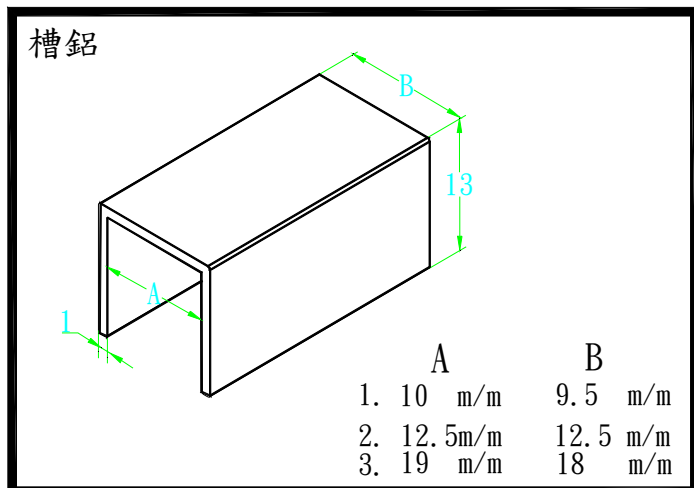
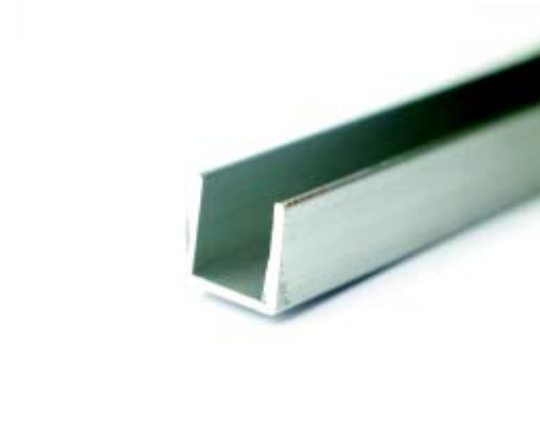

- B3031 3分槽鋁
- B3032 4分槽鋁
- B3033 6分槽鋁

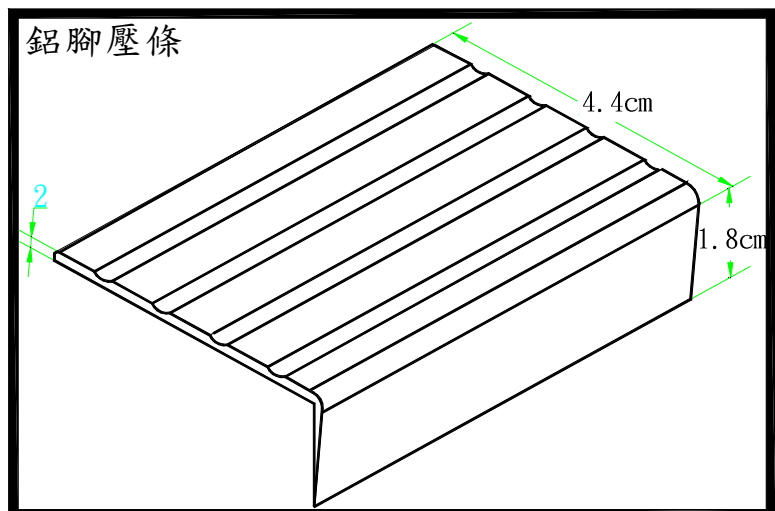
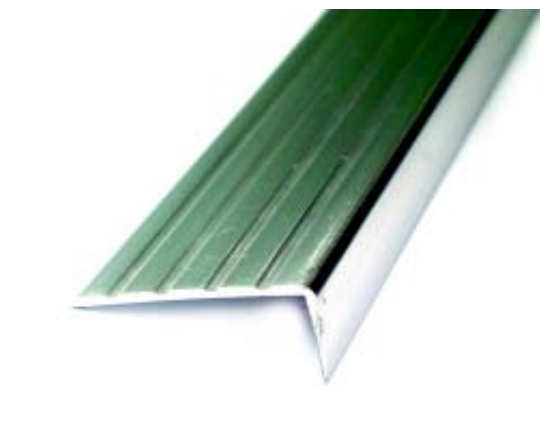

- B3051 鋁腳壓條薄鋁腳壓條 4.4x1.8x6M



B3063 T型角鋁 10mm\*10mm 6M  
B3064 T型角鋁 B 6.5MM\*6.5MM 6M

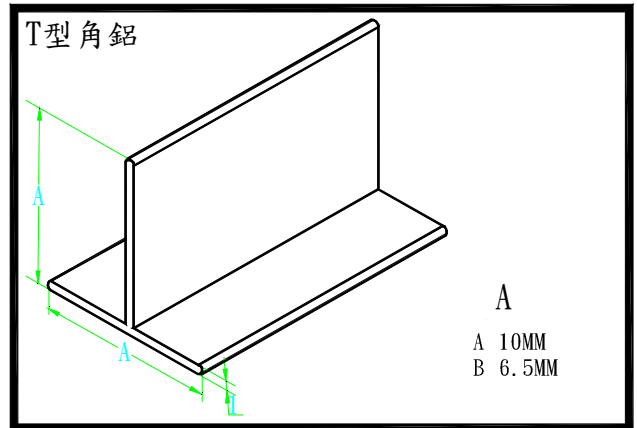

B3072 鋁壁板 5M

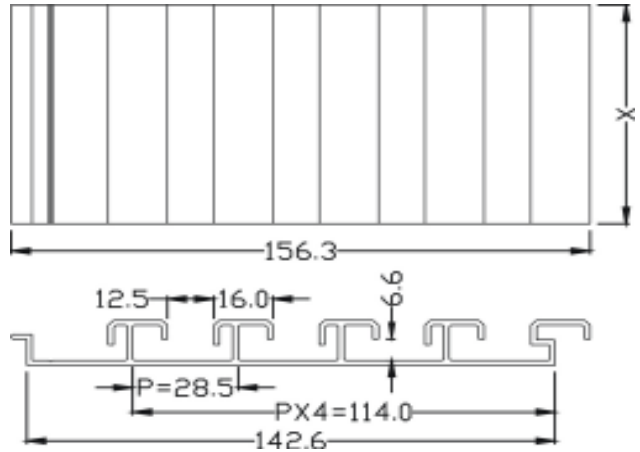

### 鋁壁板結構

如有過重或過長時，請塗上樹脂及AB膠，同時鎖上螺絲。

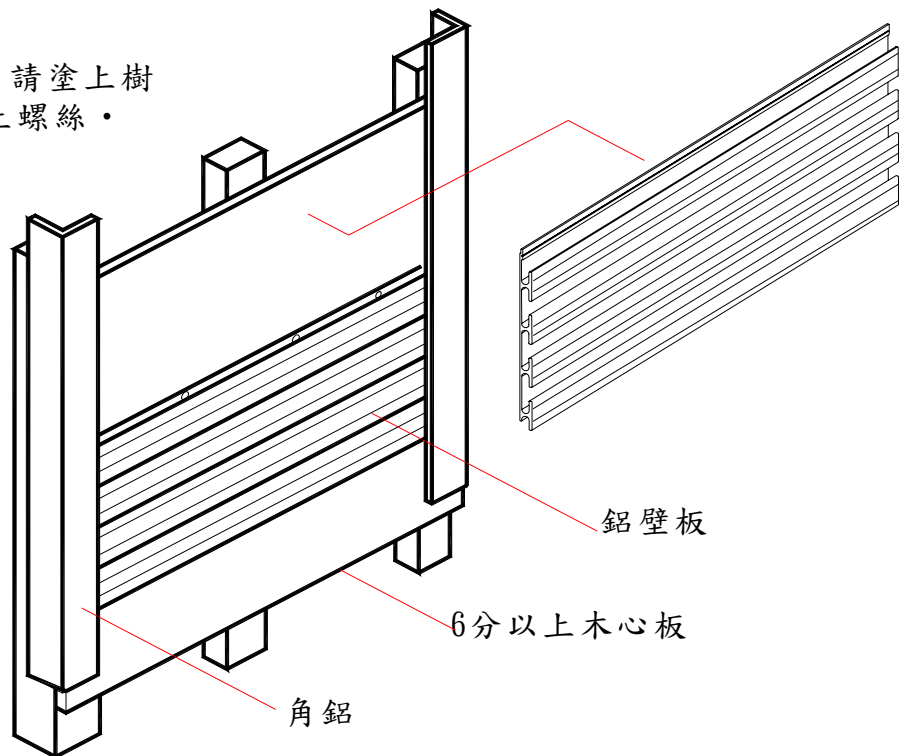



專利號碼：台灣 M242108  
日本 3099639  
中國 ZL03209647. X



B3076 專利展示塑膠壓修隔板

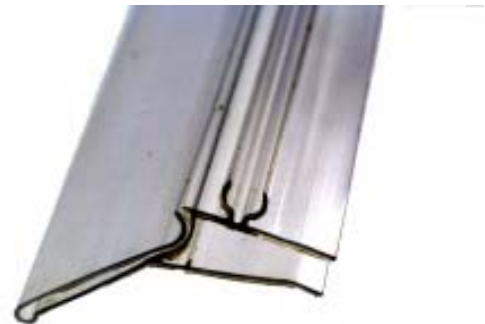

B3077 專利展示塑膠壓修隔板 - 壓條 8 尺  
B3078 專利展示塑膠壓修隔板 - 壓條 9 尺  
B3079 專利展示塑膠壓修隔板 - 壓條 12 尺



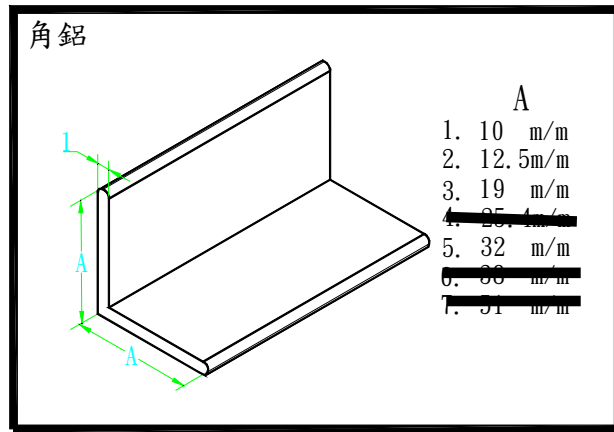
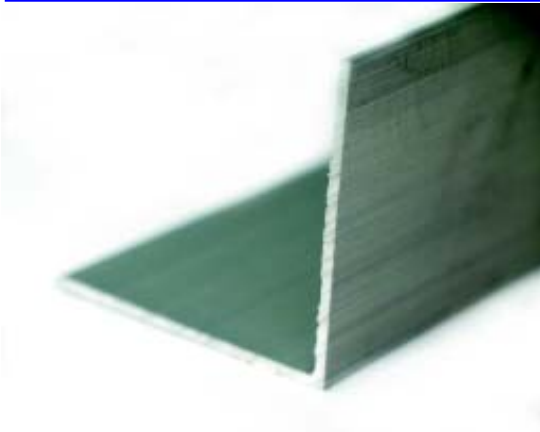

- B3011 3分角鋁
- B3012 4分角鋁
- B3013 6分角鋁
- B3015 1.1/4英吋角鋁

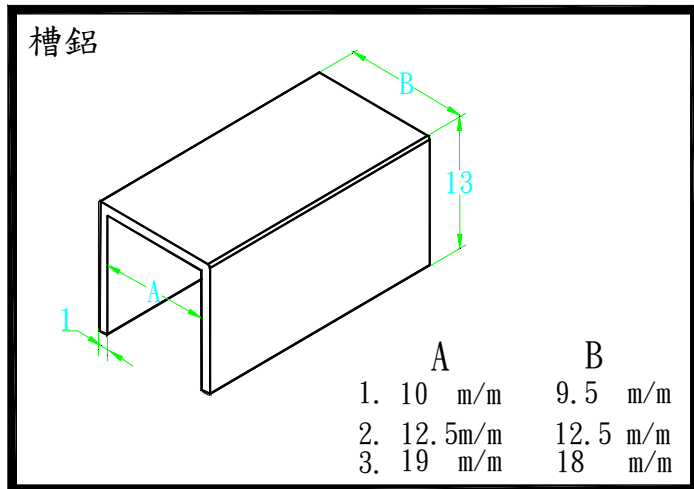

- B3031 3分槽鋁
- B3032 4分槽鋁
- B3033 6分槽鋁

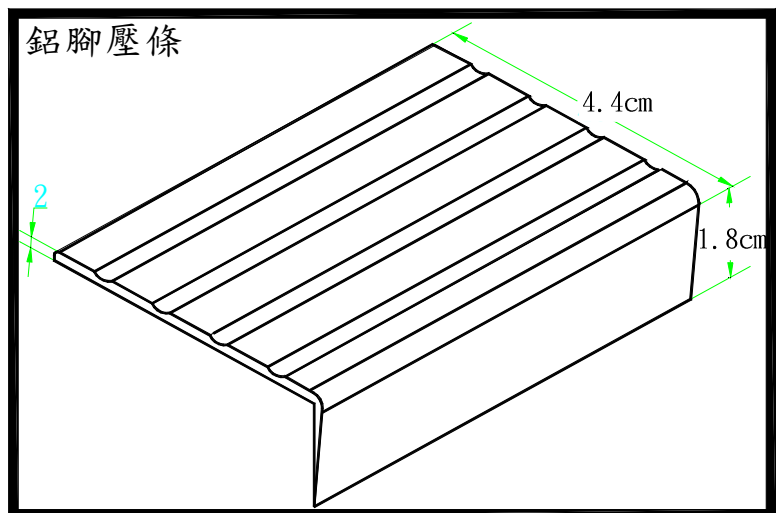
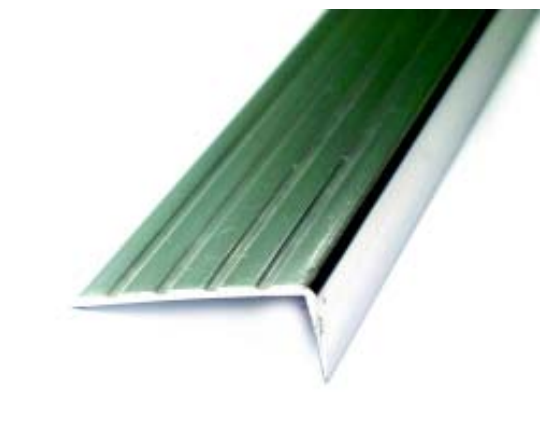

- B3051 鋁腳壓條薄鋁腳壓條 4.4x1.8x6M



B3063 T型角鋁 10mm\*10mm 6M  
B3064 T型角鋁 B 6.5MM\*6.5MM 6M

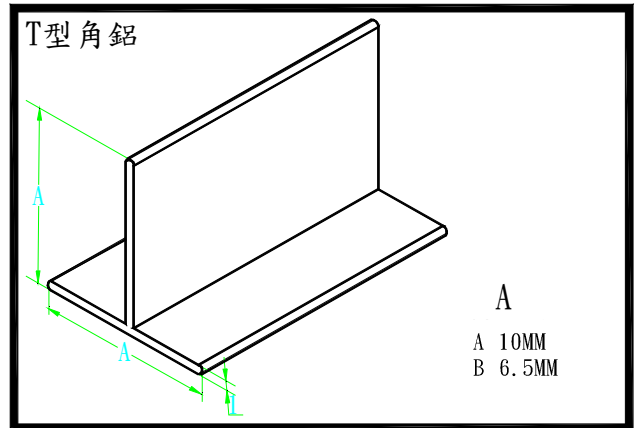

B3072 鋁壁板 5M

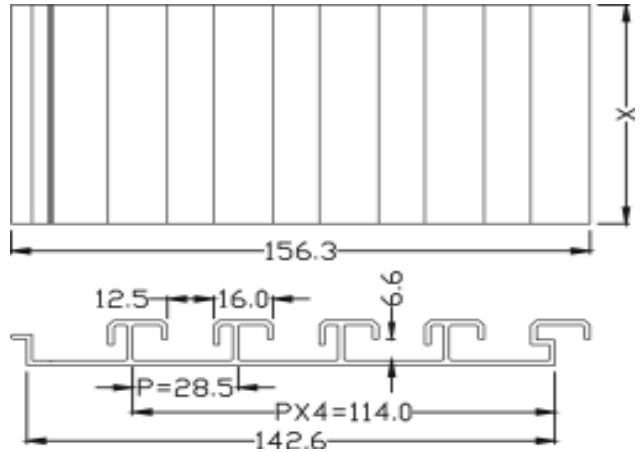

### 鋁壁板結構

如有過重或過長時，請塗上樹脂及AB膠，同時鎖上螺絲。

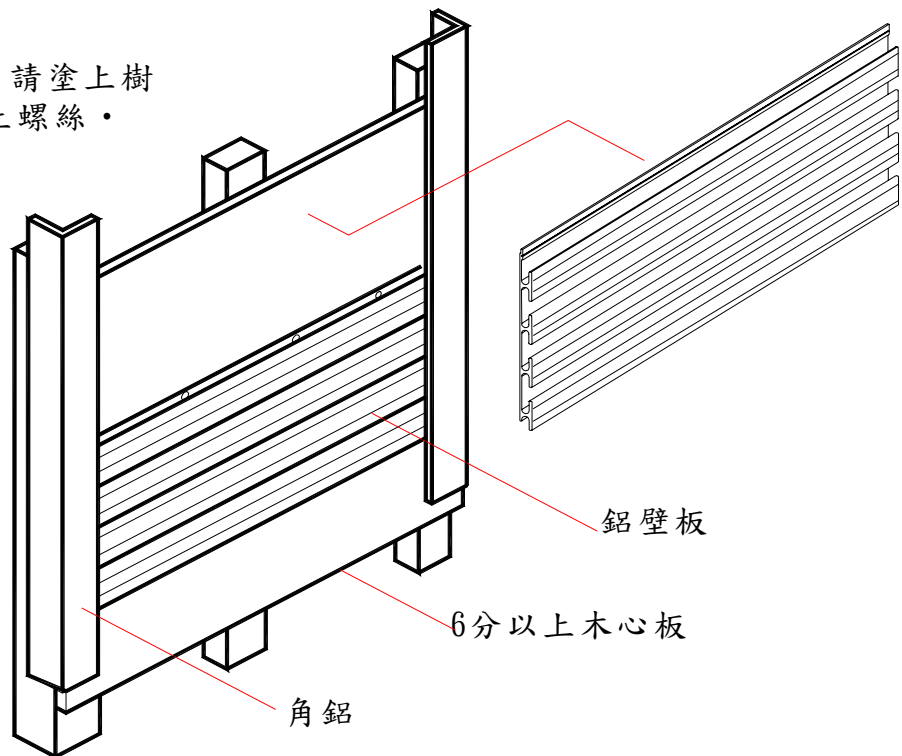



專利號碼：台灣 M242108  
日本 3099639  
中國 ZL03209647. X



B3076 專利展示塑膠壓修隔板

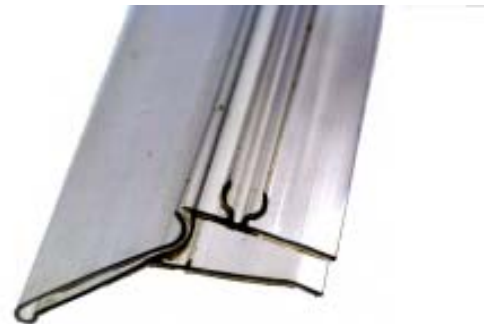

B3077 專利展示塑膠壓修隔板 - 壓條 8 尺  
B3078 專利展示塑膠壓修隔板 - 壓條 9 尺  
B3079 專利展示塑膠壓修隔板 - 壓條 12 尺





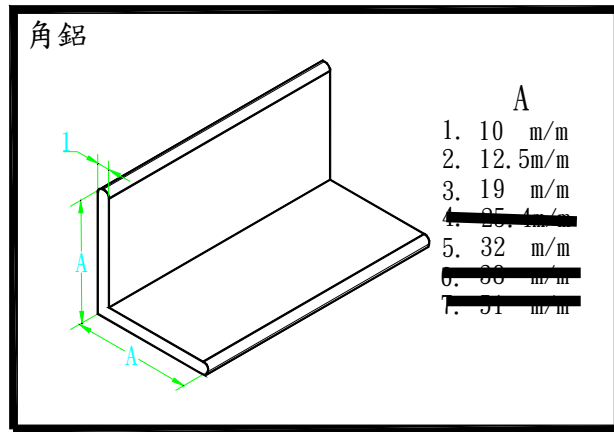
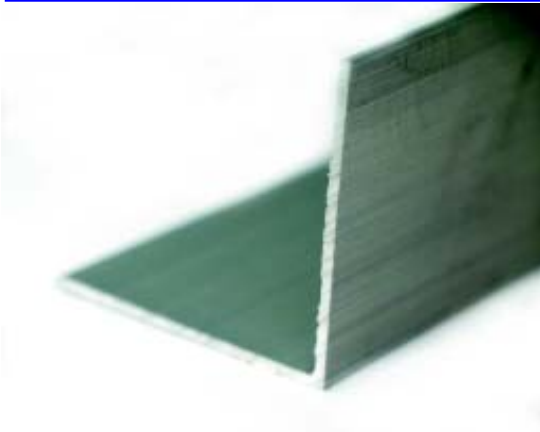

- B3011 3分角鋁
- B3012 4分角鋁
- B3013 6分角鋁
- B3015 1.1/4英吋角鋁

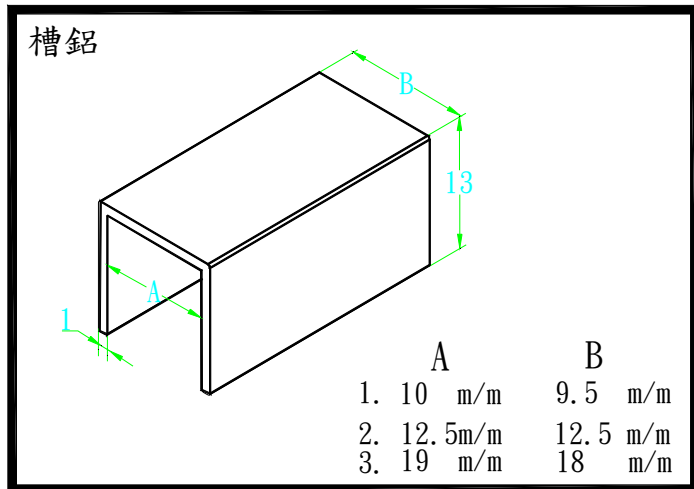

- B3031 3分槽鋁
- B3032 4分槽鋁
- B3033 6分槽鋁

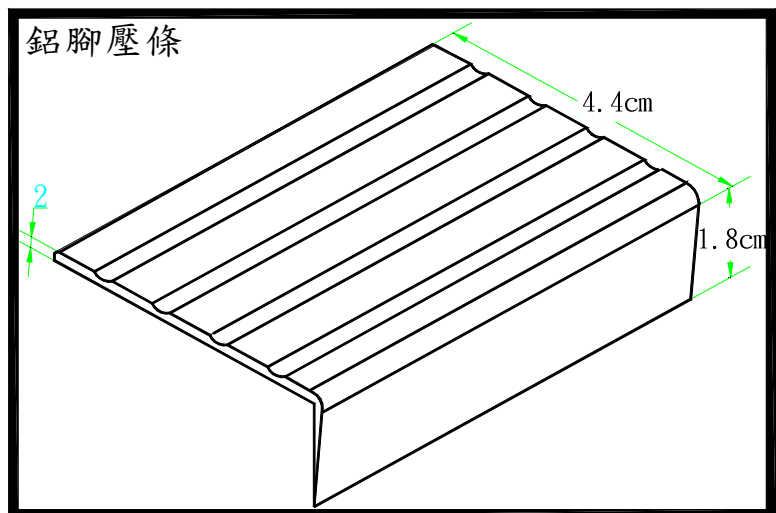
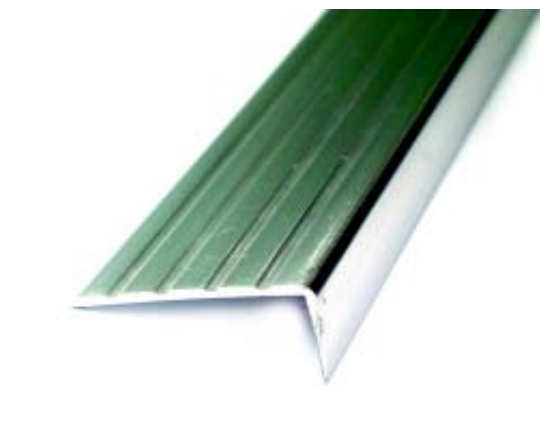

- B3051 鋁腳壓條薄鋁腳壓條 4.4x1.8x6M



B3063 T型角鋁 10mm\*10mm 6M  
B3064 T型角鋁 B 6.5MM\*6.5MM 6M

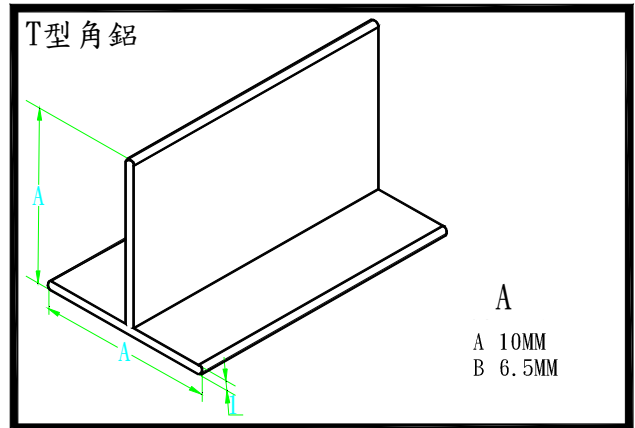

B3072 鋁壁板 5M

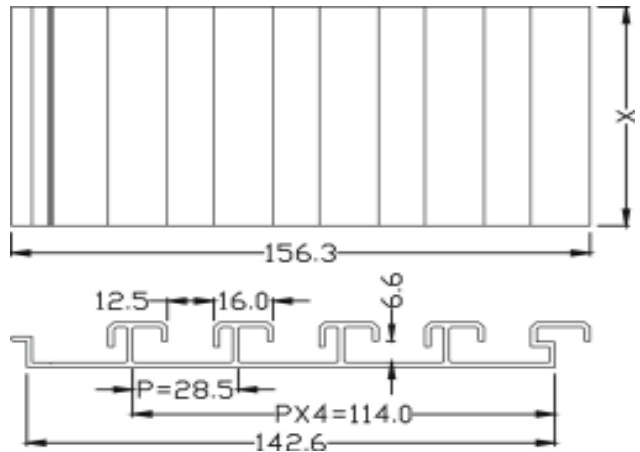

### 鋁壁板結構

如有過重或過長時，請塗上樹脂及AB膠，同時鎖上螺絲。

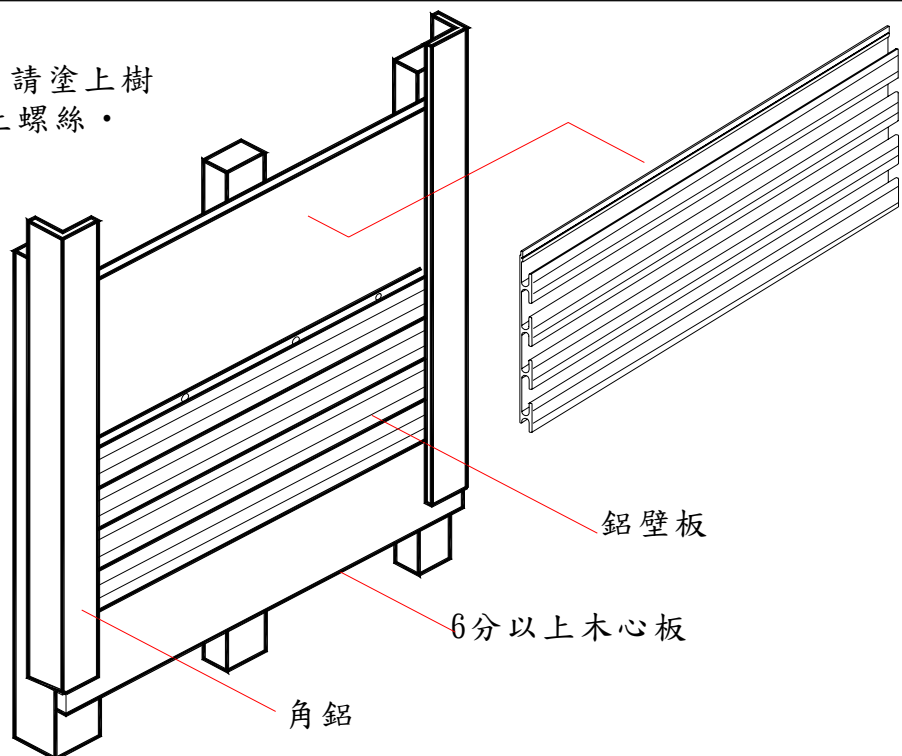



專利號碼：台灣 M242108  
日本 3099639  
中國 ZL03209647. X



B3076 專利展示塑膠壓修隔板

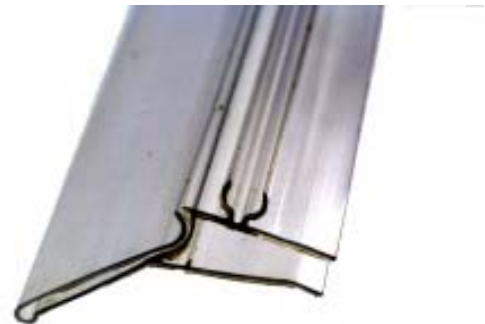

B3077 專利展示塑膠壓修隔板 - 壓條 8 尺  
B3078 專利展示塑膠壓修隔板 - 壓條 9 尺  
B3079 專利展示塑膠壓修隔板 - 壓條 12 尺



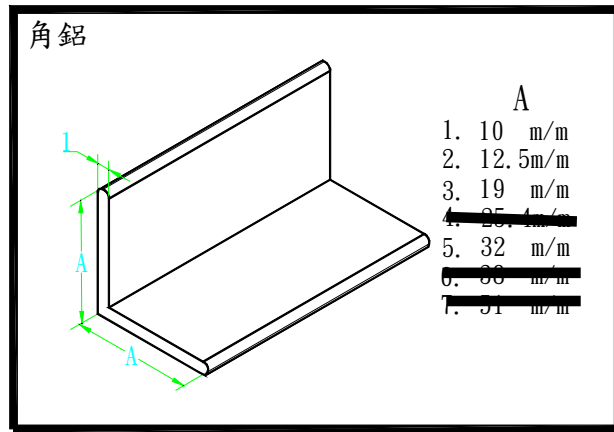
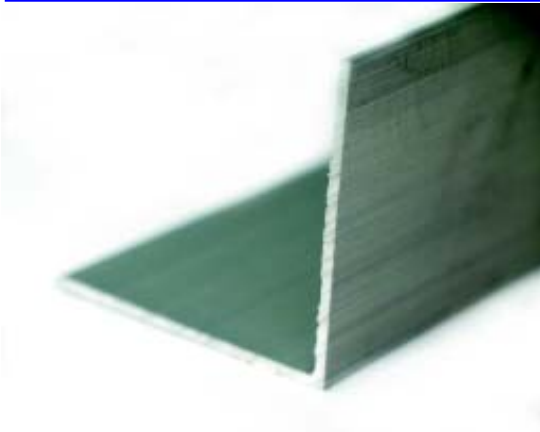

- B3011 3分角鋁
- B3012 4分角鋁
- B3013 6分角鋁
- B3015 1.1/4 英寸角鋁

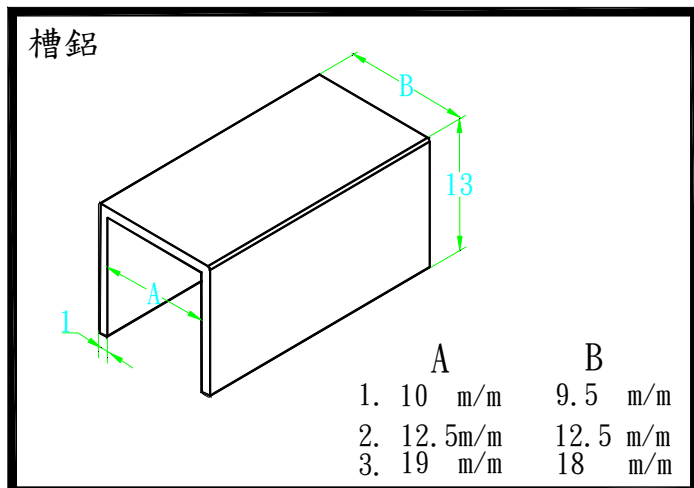
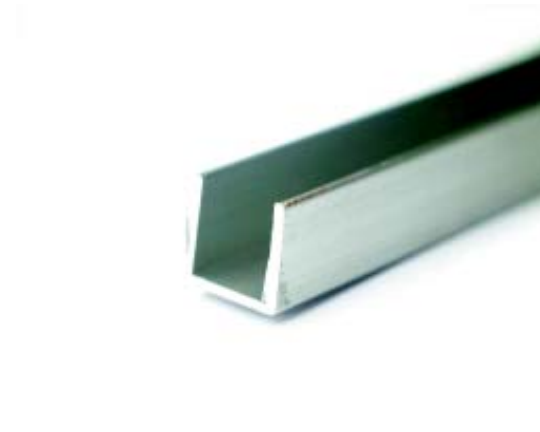

- B3031 3分槽鋁
- B3032 4分槽鋁
- B3033 6分槽鋁

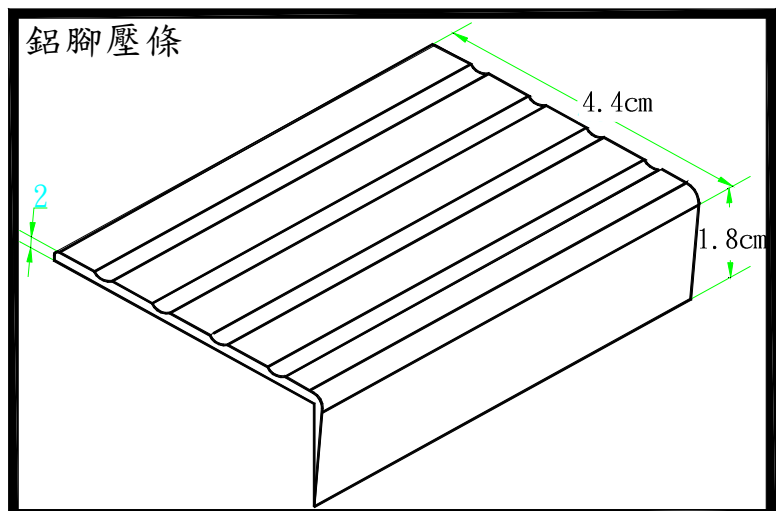
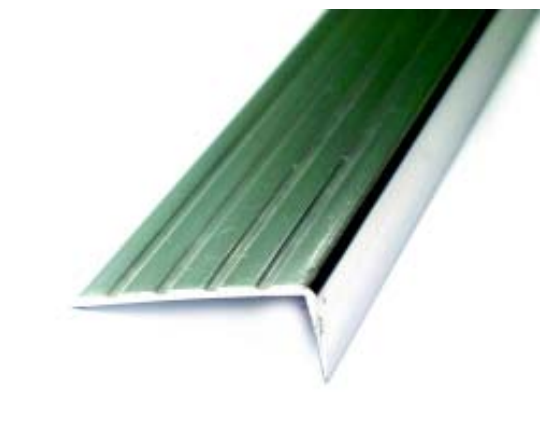

- B3051 鋁腳壓條薄鋁腳壓條 4.4x1.8x6M



B3063 T型角鋁 10mm\*10mm 6M  
B3064 T型角鋁 B 6.5MM\*6.5MM 6M

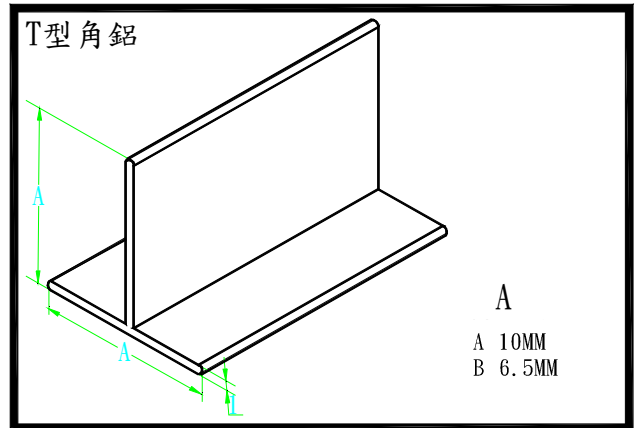

B3072 鋁壁板 5M

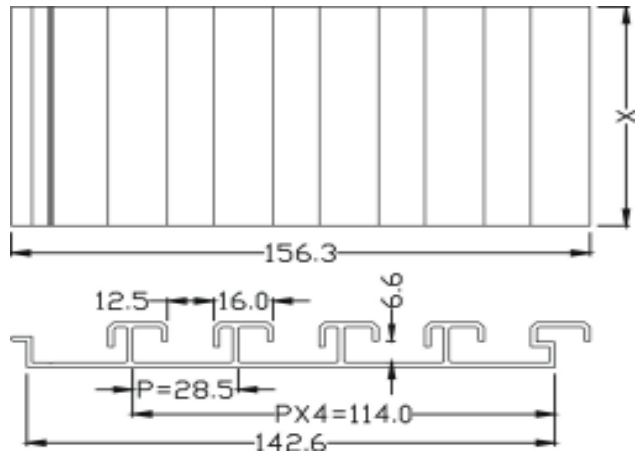

### 鋁壁板結構

如有過重或過長時，請塗上樹脂及AB膠，同時鎖上螺絲。

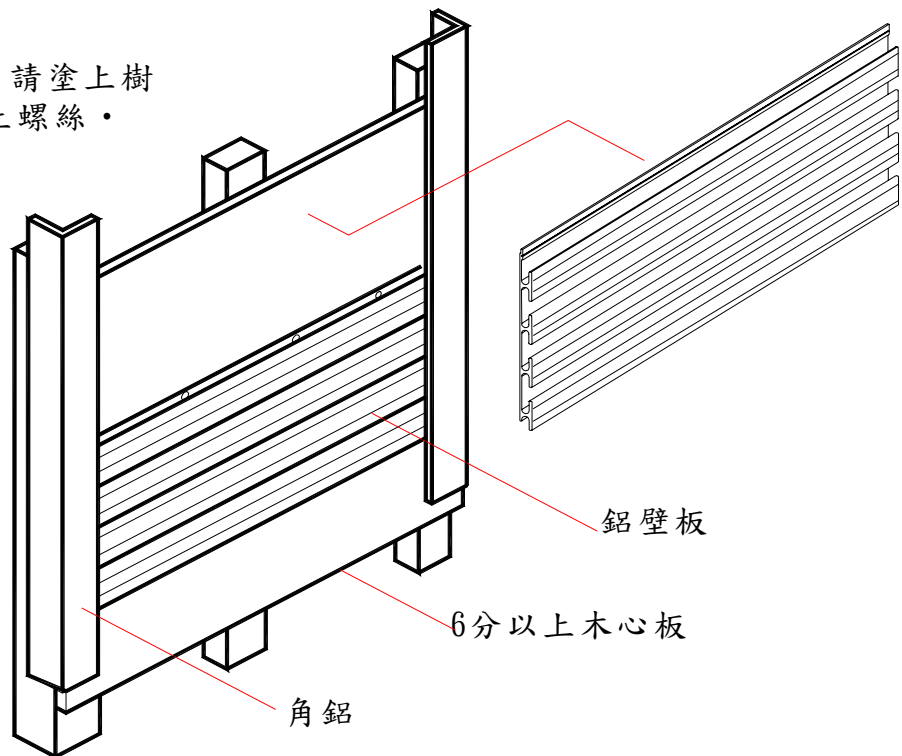



專利號碼：台灣 M242108  
日本 3099639  
中國 ZL03209647. X



B3076 專利展示塑膠壓修隔板

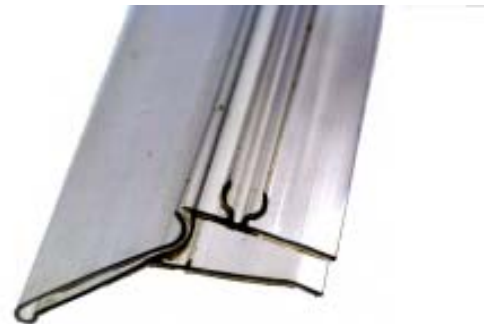

B3077 專利展示塑膠壓修隔板 - 壓條 8 尺  
B3078 專利展示塑膠壓修隔板 - 壓條 9 尺  
B3079 專利展示塑膠壓修隔板 - 壓條 12 尺





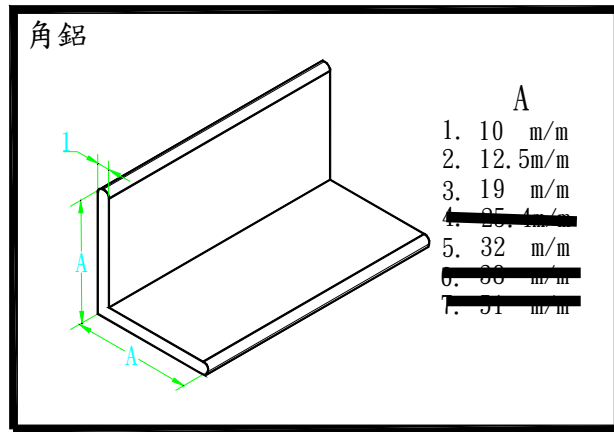
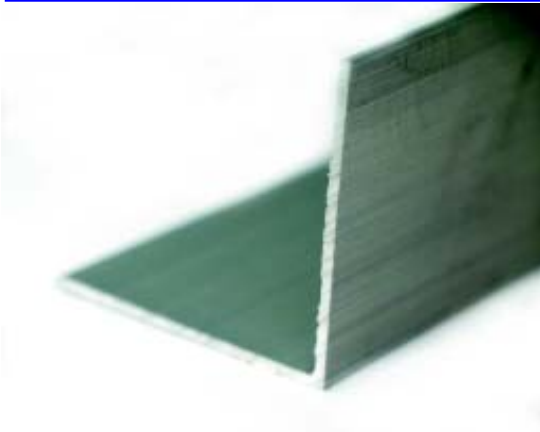

- B3011 3分角鋁
- B3012 4分角鋁
- B3013 6分角鋁
- B3015 1.1/4英吋角鋁

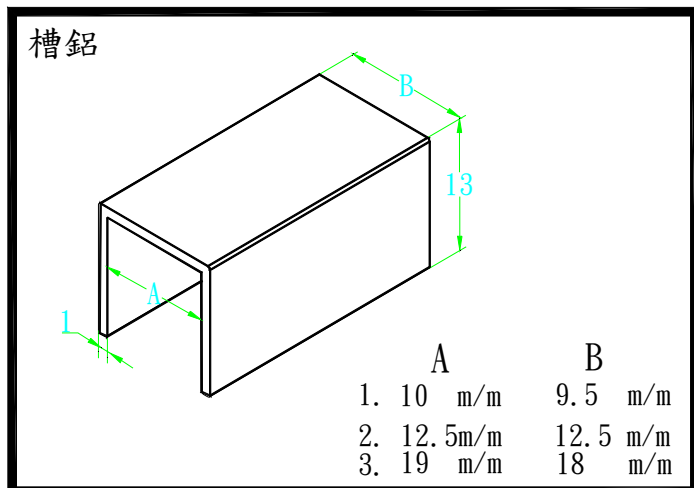
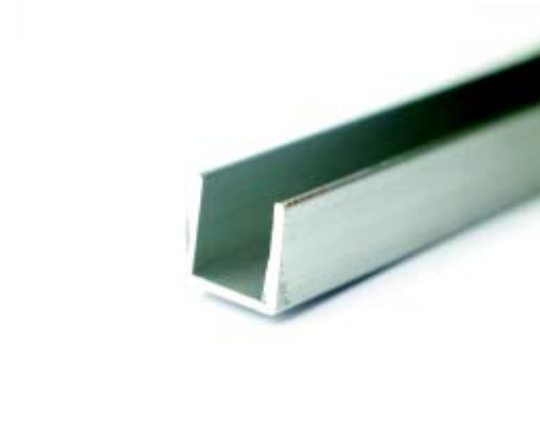

- B3031 3分槽鋁
- B3032 4分槽鋁
- B3033 6分槽鋁

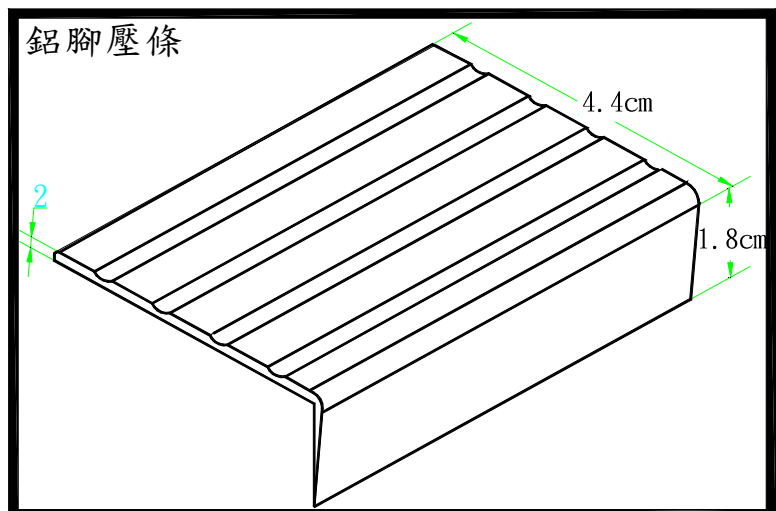
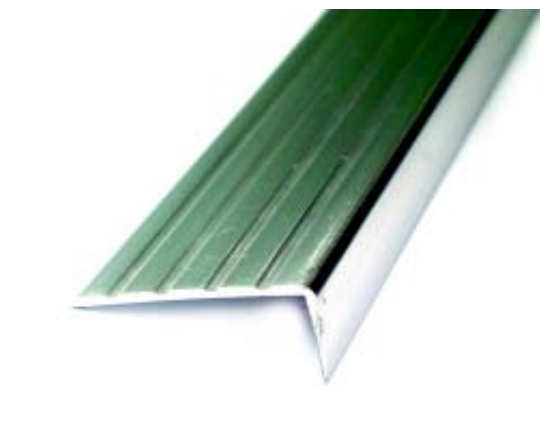

- B3051 鋁腳壓條薄鋁腳壓條 4.4x1.8x6M



B3063 T型角鋁 10mm\*10mm 6M  
B3064 T型角鋁 B 6.5MM\*6.5MM 6M

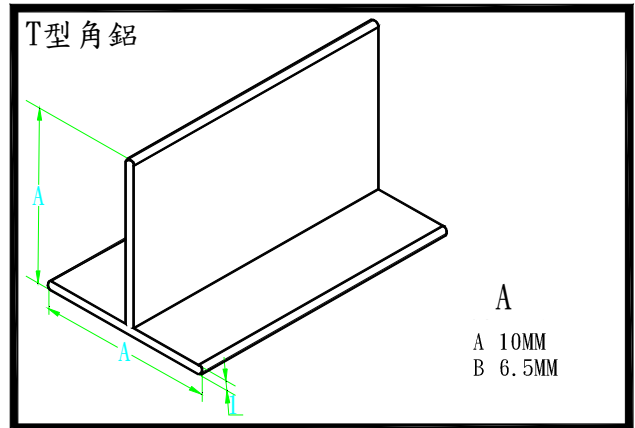

B3072 鋁壁板 5M

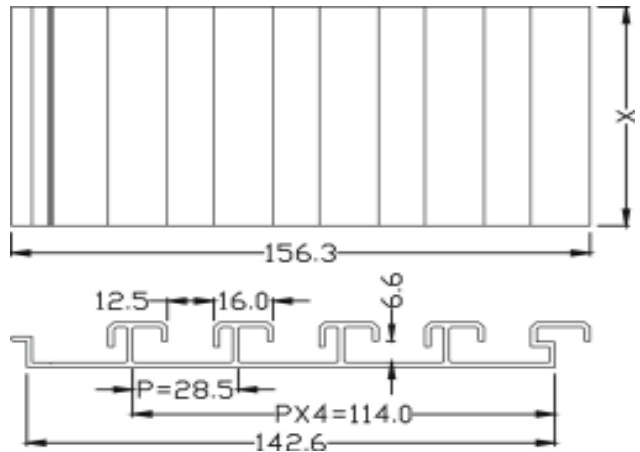

### 鋁壁板結構

如有過重或過長時，請塗上樹脂及AB膠，同時鎖上螺絲。

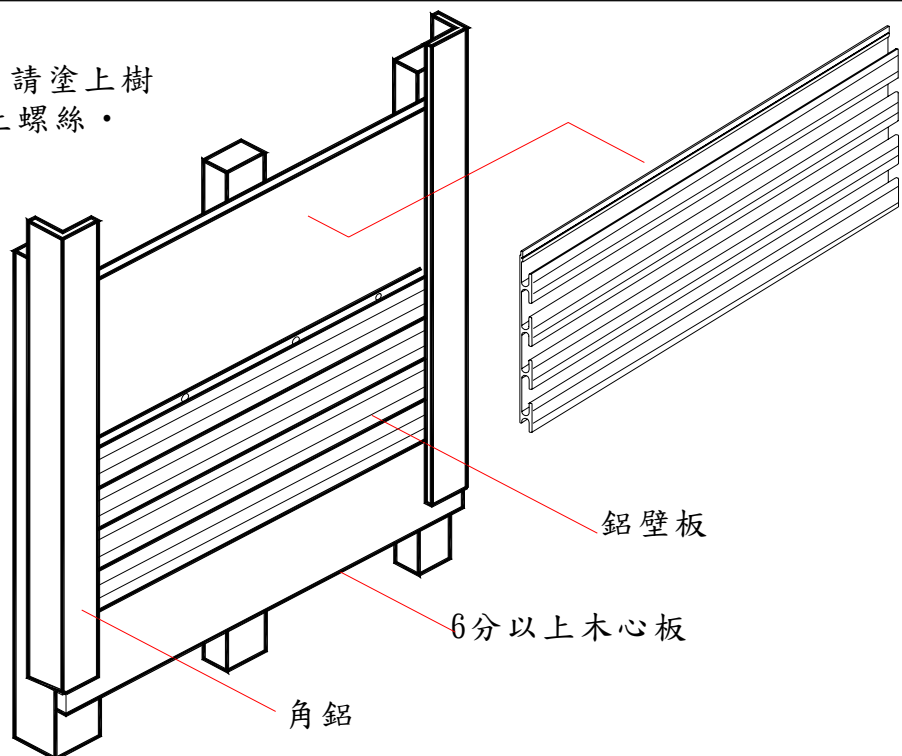



專利號碼：台灣 M242108  
日本 3099639  
中國 ZL03209647. X



B3076 專利展示塑膠壓修隔板

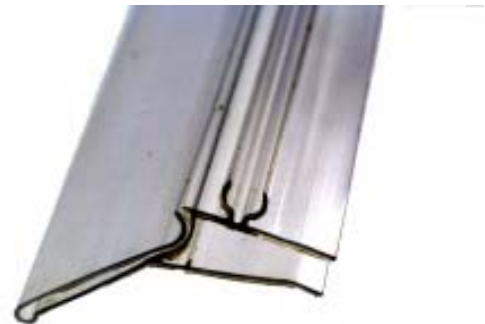

B3077 專利展示塑膠壓修隔板 - 壓條 8 尺  
B3078 專利展示塑膠壓修隔板 - 壓條 9 尺  
B3079 專利展示塑膠壓修隔板 - 壓條 12 尺



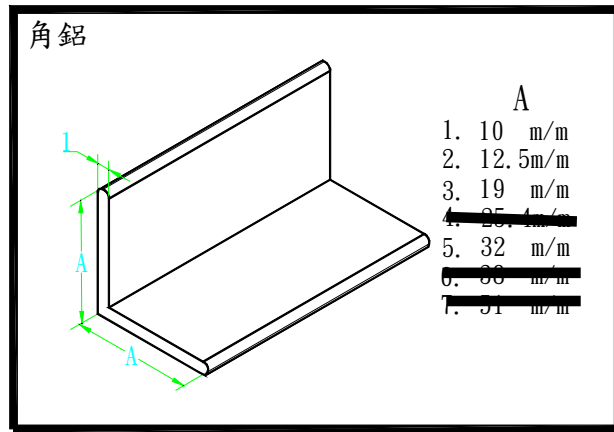
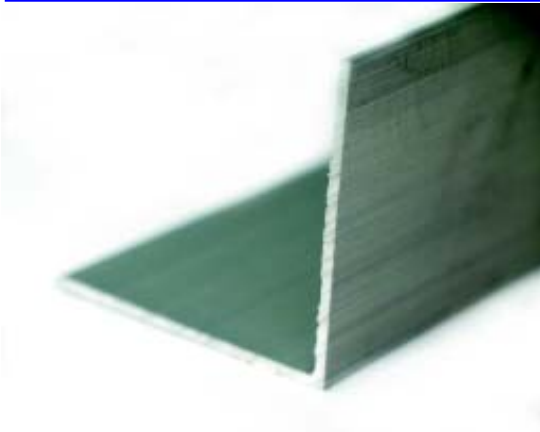

- B3011 3分角鋁
- B3012 4分角鋁
- B3013 6分角鋁
- B3015 1.1/4英吋角鋁

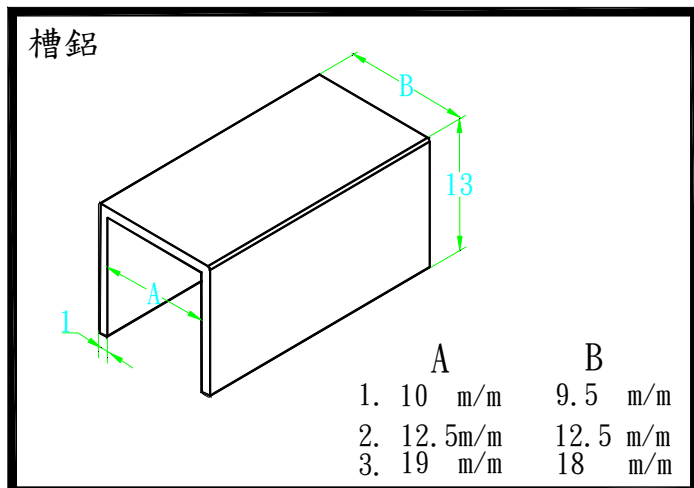
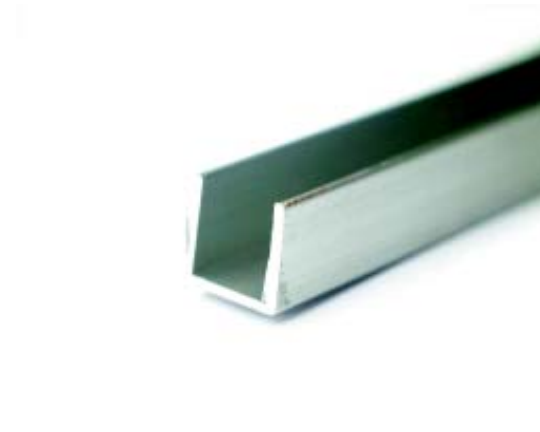

- B3031 3分槽鋁
- B3032 4分槽鋁
- B3033 6分槽鋁

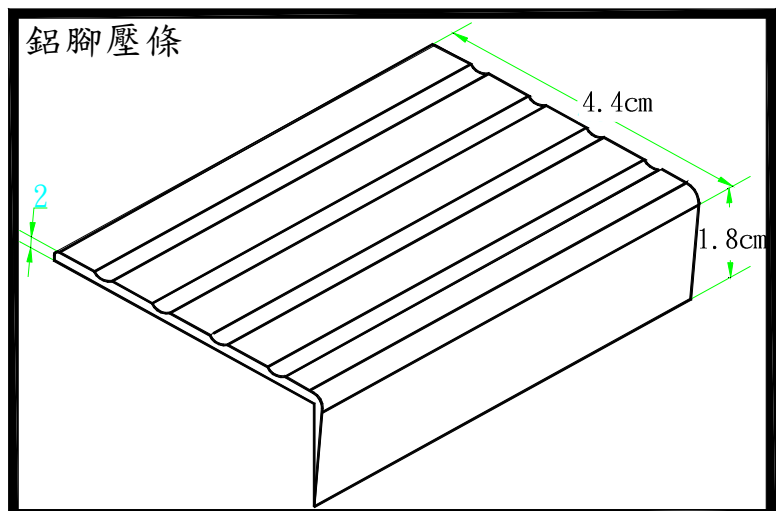
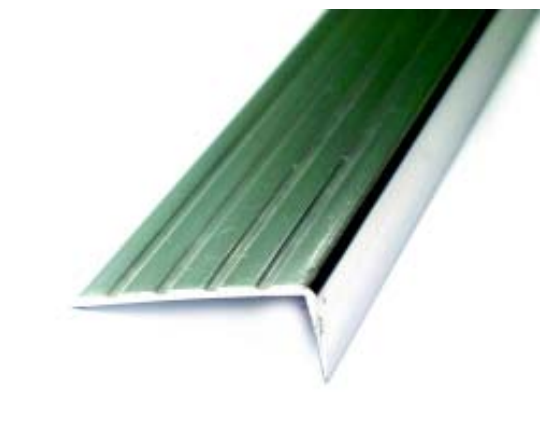

- B3051 鋁腳壓條薄鋁腳壓條 4.4x1.8x6M



B3063 T型角鋁 10mm\*10mm 6M  
B3064 T型角鋁 B 6.5MM\*6.5MM 6M

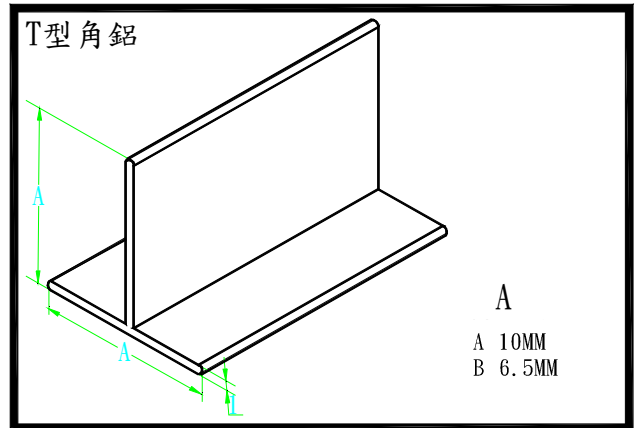

B3072 鋁壁板 5M

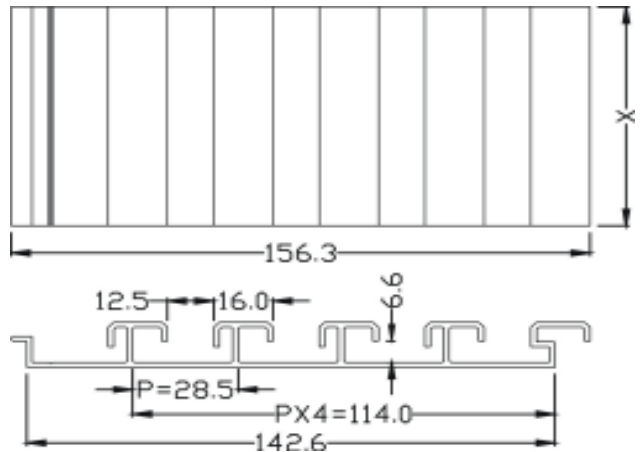

### 鋁壁板結構

如有過重或過長時，請塗上樹脂及AB膠，同時鎖上螺絲。

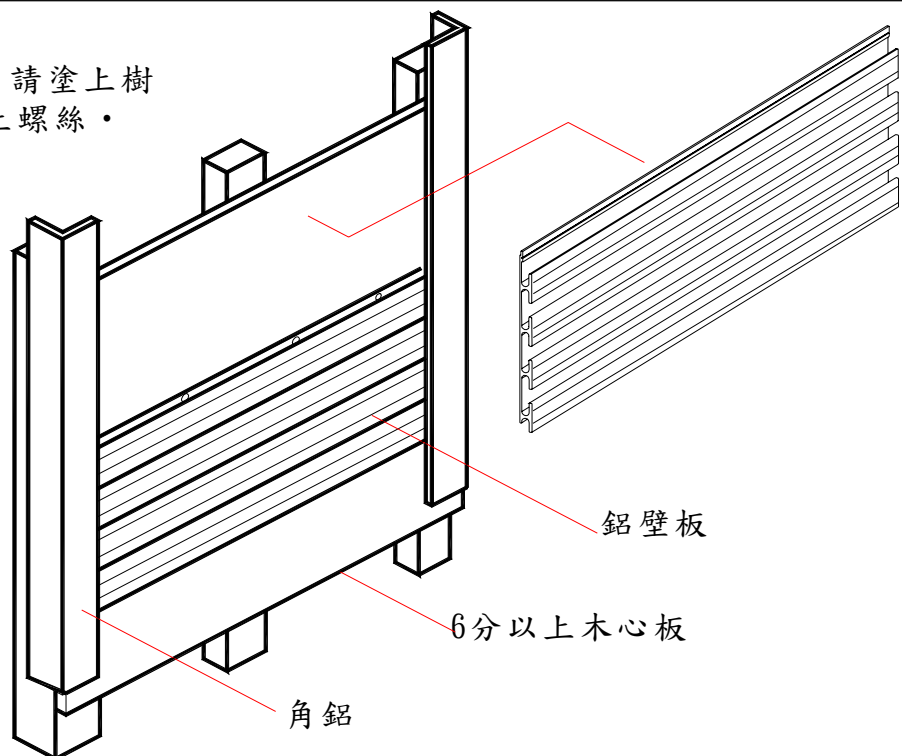



專利號碼：台灣 M242108  
日本 3099639  
中國 ZL03209647. X



B3076 專利展示塑膠壓修隔板

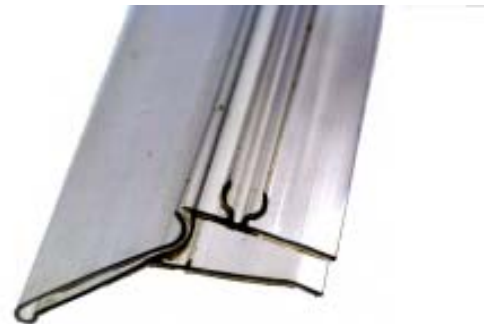

B3077 專利展示塑膠壓修隔板 - 壓條 8 尺  
B3078 專利展示塑膠壓修隔板 - 壓條 9 尺  
B3079 專利展示塑膠壓修隔板 - 壓條 12 尺





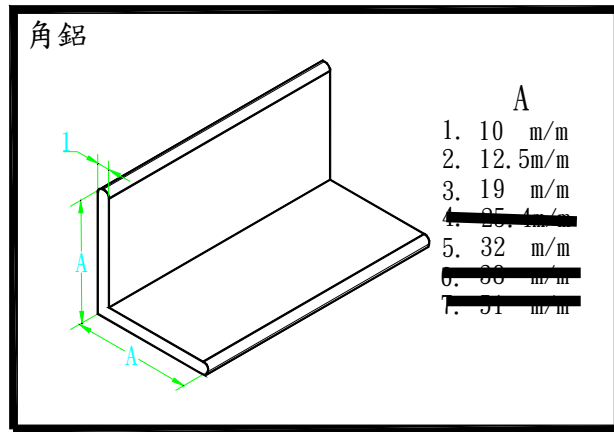
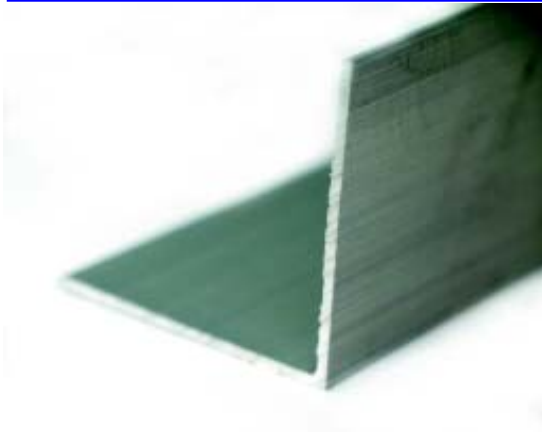

- B3011 3分角鋁
- B3012 4分角鋁
- B3013 6分角鋁
- B3015 1.1/4英吋角鋁

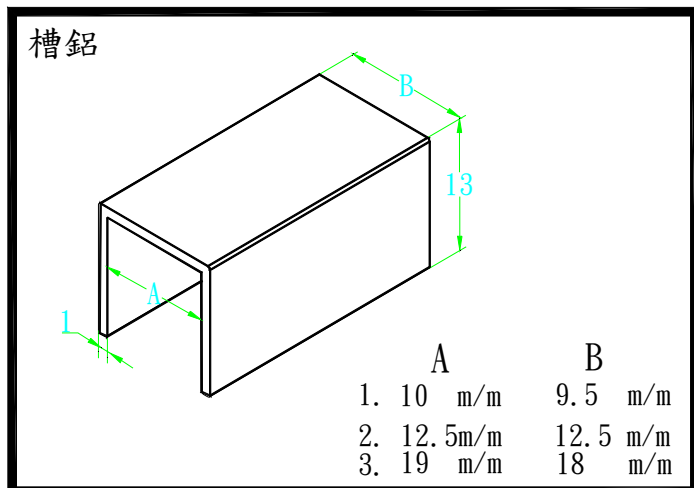
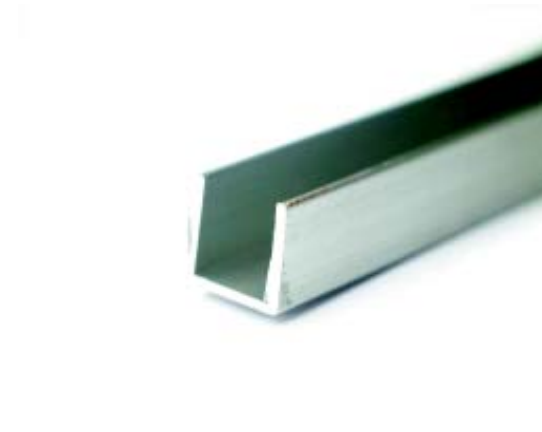

- B3031 3分槽鋁
- B3032 4分槽鋁
- B3033 6分槽鋁

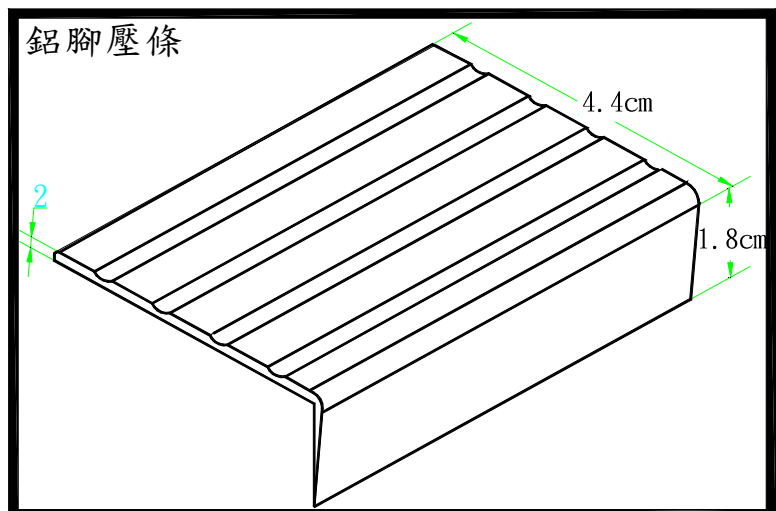
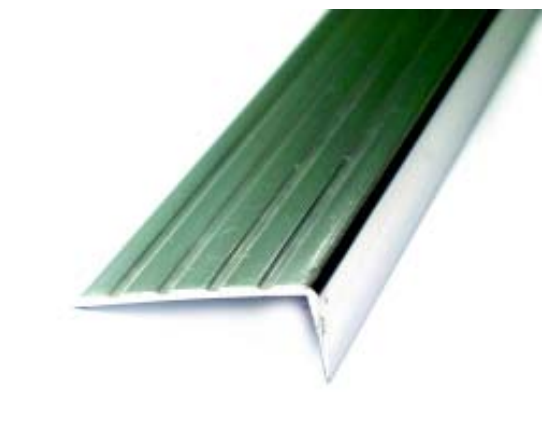

- B3051 鋁腳壓條薄鋁腳壓條 4.4x1.8x6M



B3063 T型角鋁 10mm\*10mm 6M  
B3064 T型角鋁 B 6.5MM\*6.5MM 6M

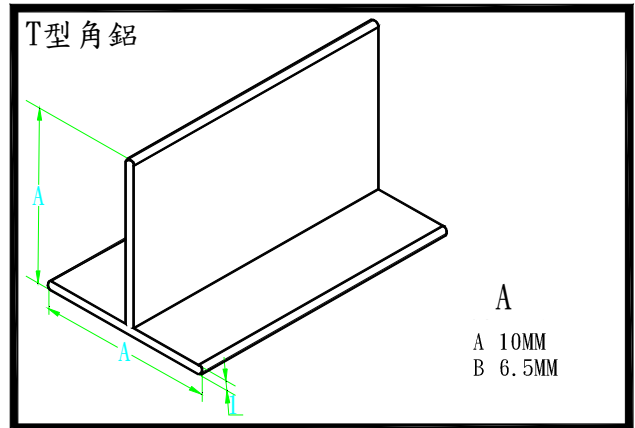

B3072 鋁壁板 5M

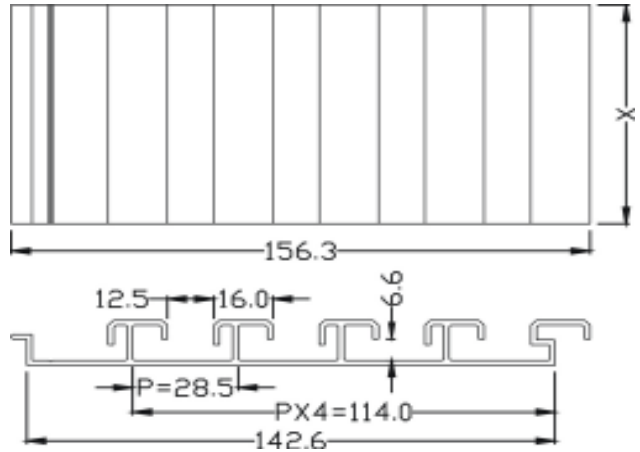

### 鋁壁板結構

如有過重或過長時，請塗上樹脂及AB膠，同時鎖上螺絲。

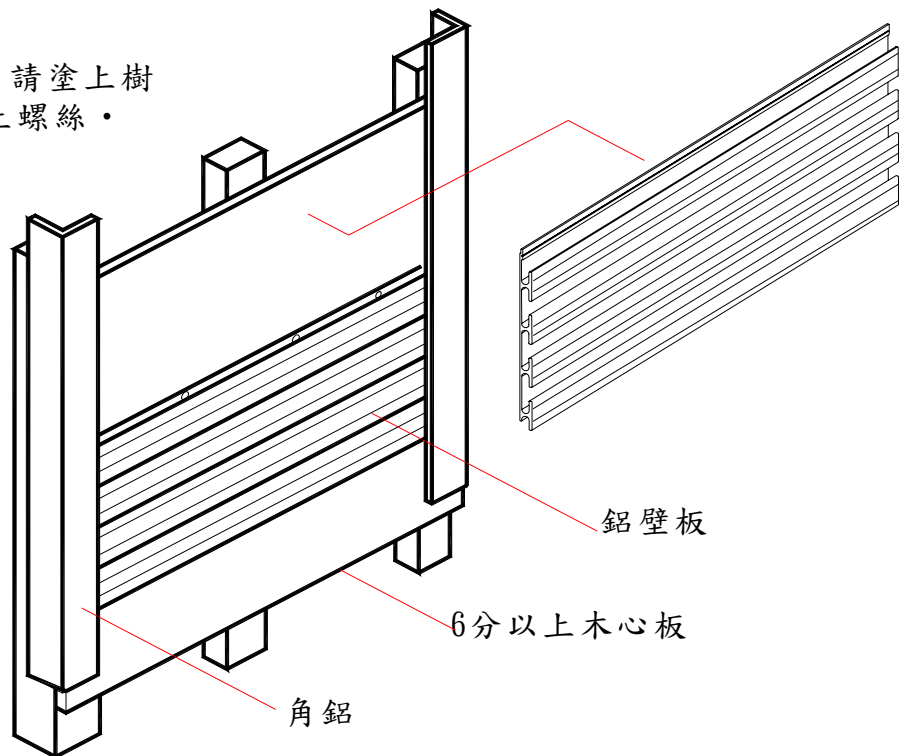



專利號碼：台灣 M242108  
日本 3099639  
中國 ZL03209647. X



B3076 專利展示塑膠壓修隔板

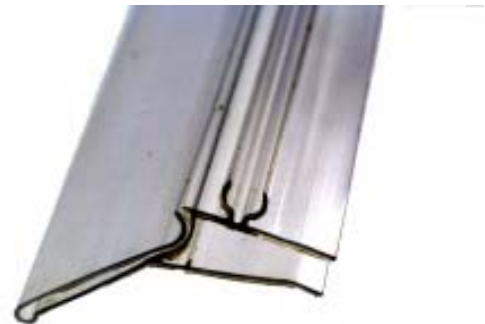

B3077 專利展示塑膠壓修隔板 - 壓條 8 尺  
B3078 專利展示塑膠壓修隔板 - 壓條 9 尺  
B3079 專利展示塑膠壓修隔板 - 壓條 12 尺



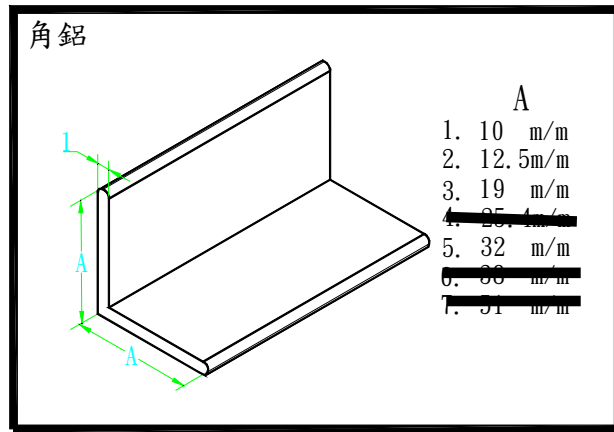
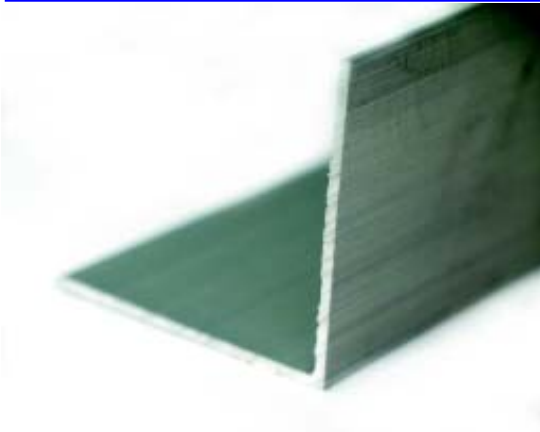

- B3011 3分角鋁
- B3012 4分角鋁
- B3013 6分角鋁
- B3015 1.1/4英吋角鋁

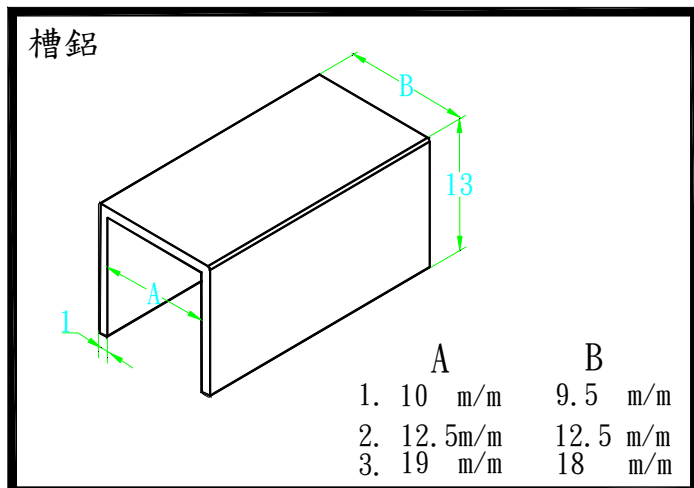
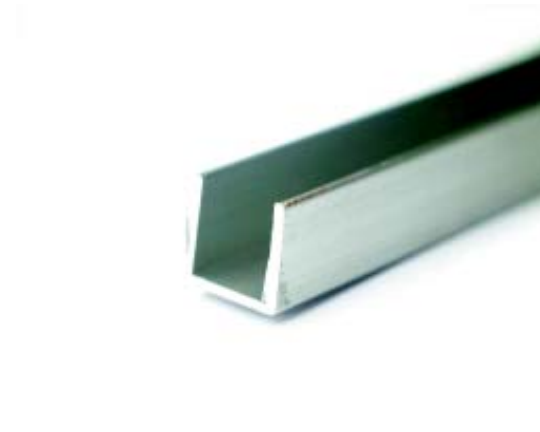

- B3031 3分槽鋁
- B3032 4分槽鋁
- B3033 6分槽鋁

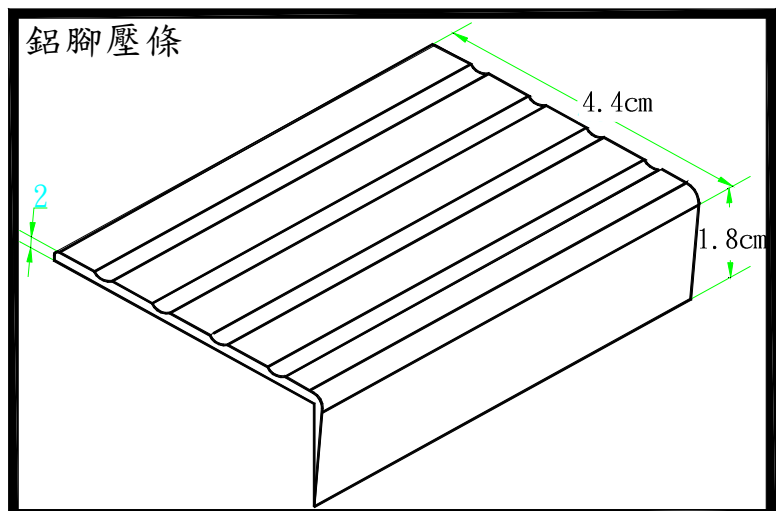
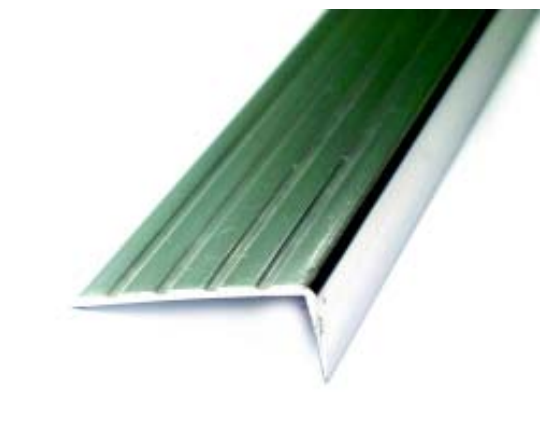

- B3051 鋁腳壓條薄鋁腳壓條 4.4x1.8x6M



B3063 T型角鋁 10mm\*10mm 6M  
B3064 T型角鋁 B 6.5MM\*6.5MM 6M

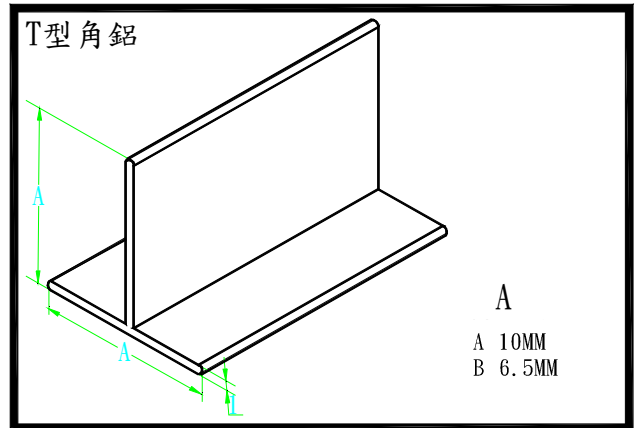

B3072 鋁壁板 5M

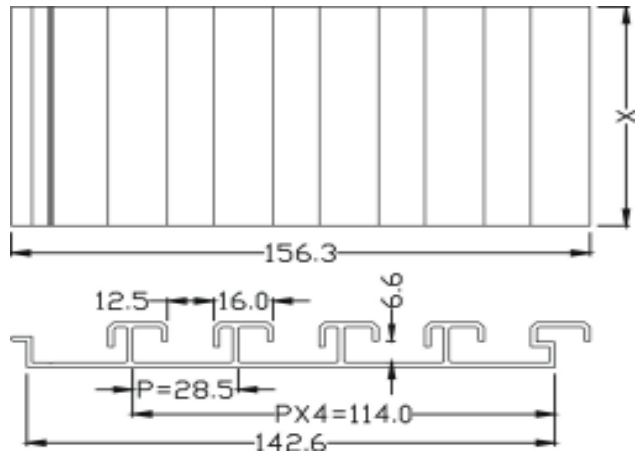

### 鋁壁板結構

如有過重或過長時，請塗上樹脂及AB膠，同時鎖上螺絲。

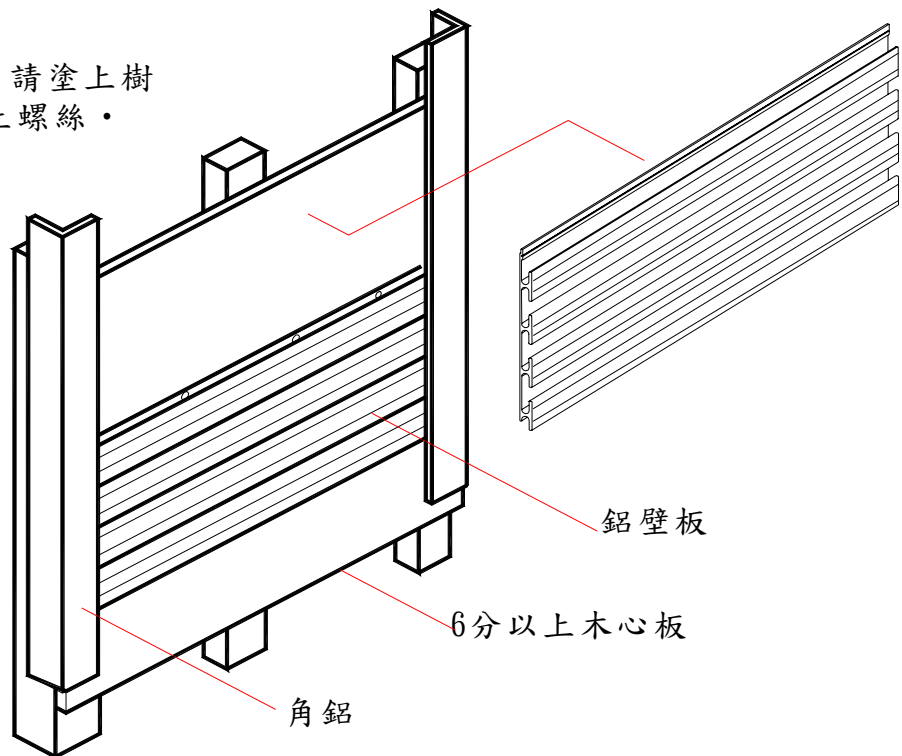



專利號碼：台灣 M242108  
日本 3099639  
中國 ZL03209647. X



B3076 專利展示塑膠壓修隔板

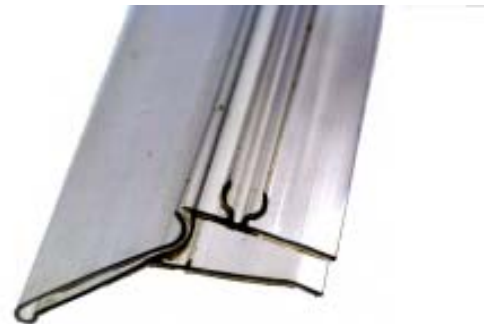

B3077 專利展示塑膠壓修隔板 - 壓條 8 尺  
B3078 專利展示塑膠壓修隔板 - 壓條 9 尺  
B3079 專利展示塑膠壓修隔板 - 壓條 12 尺

