

P10010 玻璃懸吊系統SV-40 公斤毛絲  
P10002 玻璃懸吊系統軌道-2.5M 毛絲



SV-40

承載重量：  
40 公斤



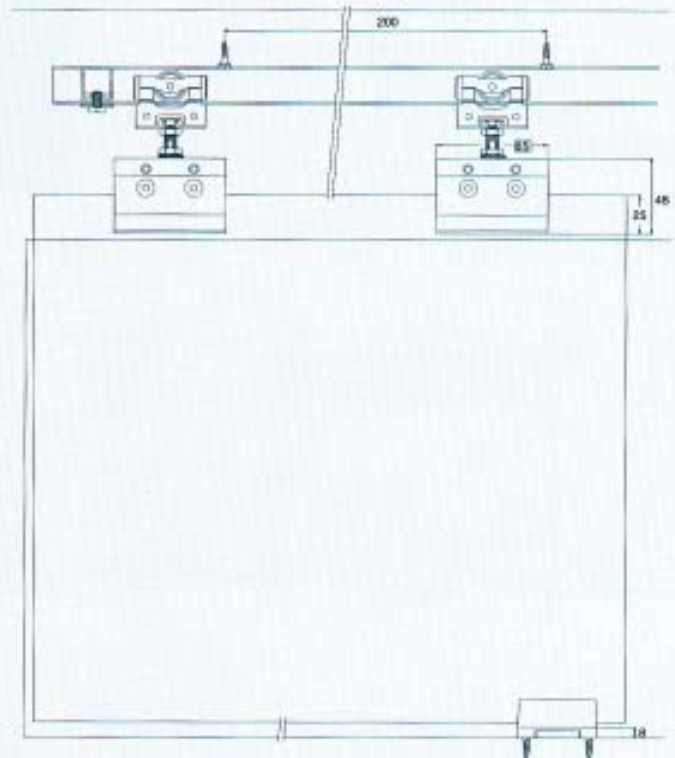
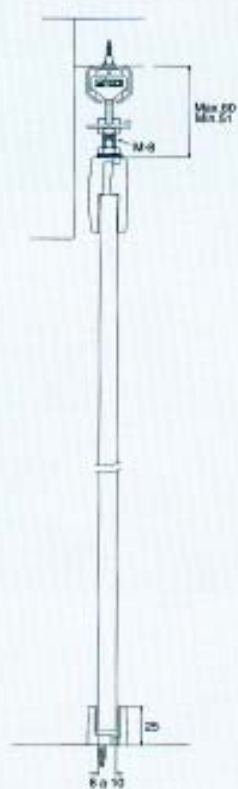
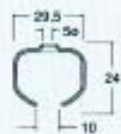

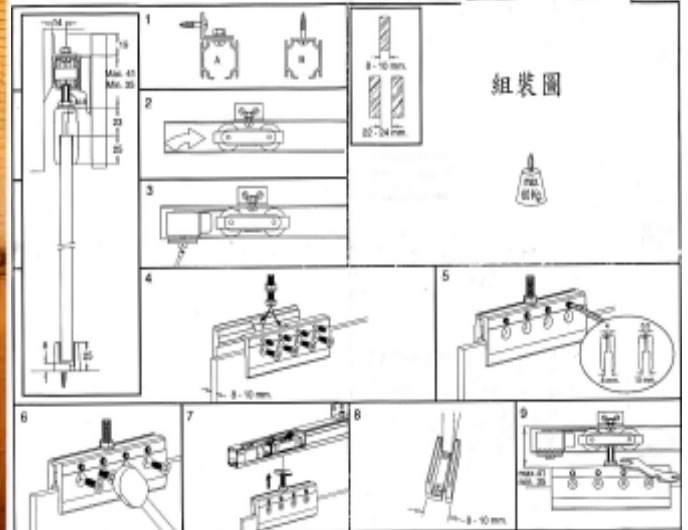

P10020 玻璃懸吊系統SV-60 公斤鋁

P10001 玻璃懸吊系統軌道-2.5M 鋁



22-24 mm



8-10 mm



30x29.5 mm

SV-A60

承載重量：  
60 公斤



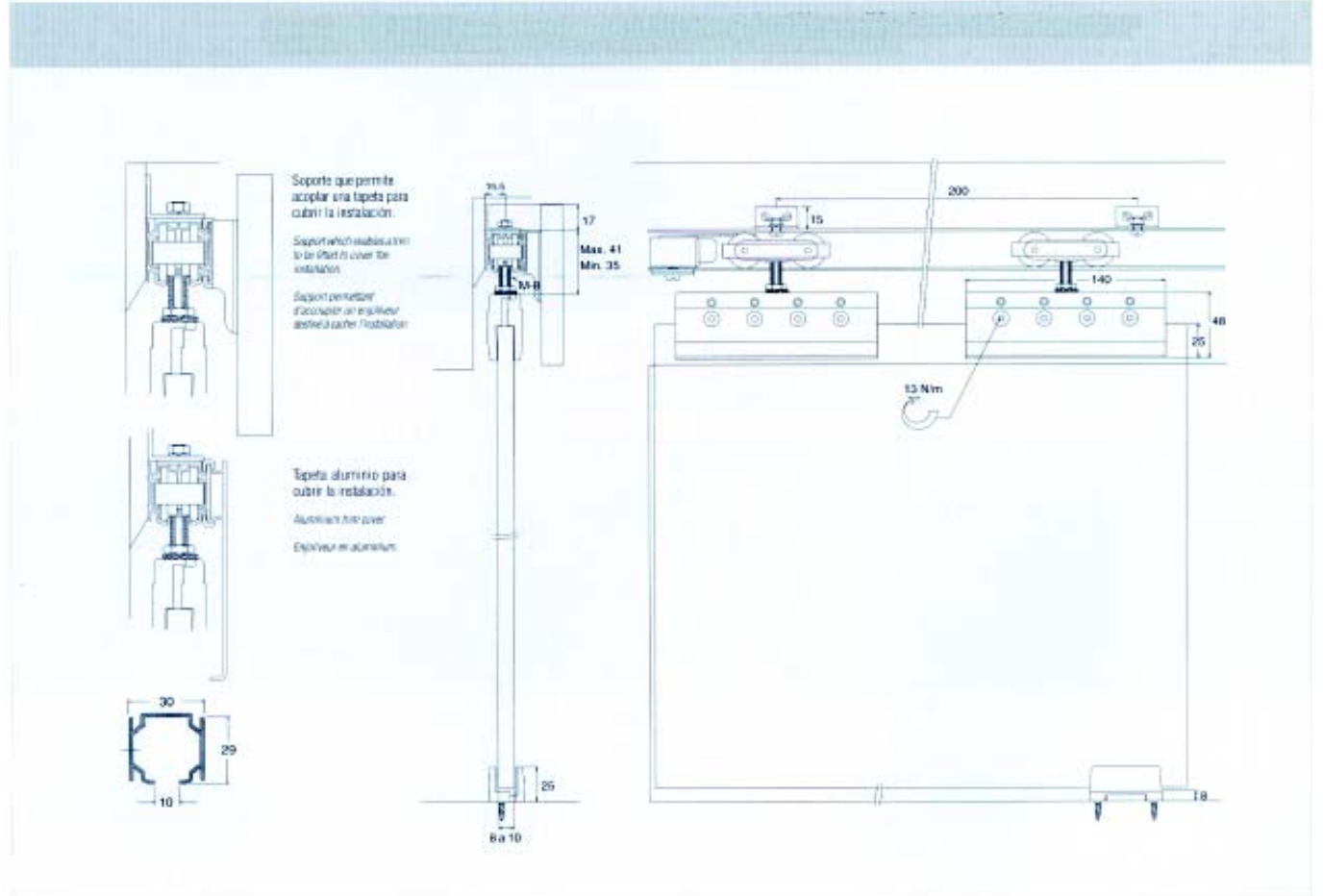

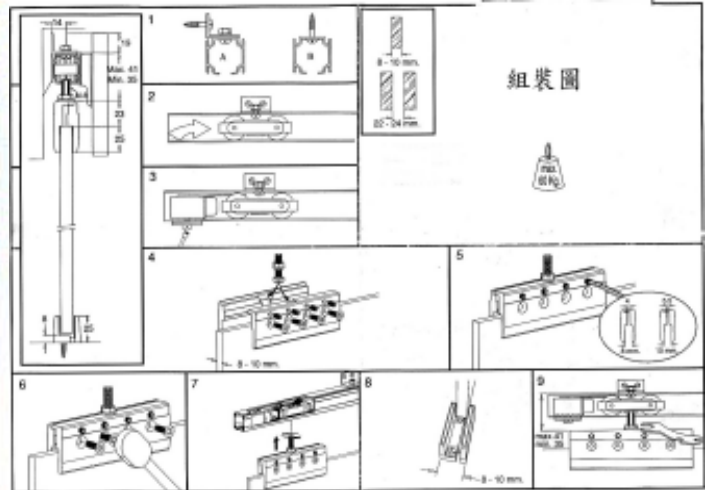

P10020F 玻璃懸吊系統 SV-60F 60 公斤  
P10001 玻璃懸吊系統軌道 -2.5M 鋁



14-16 mm



8-10 mm



30x29,5 mm

**SV-A60 F**

承載重量：  
60 公斤

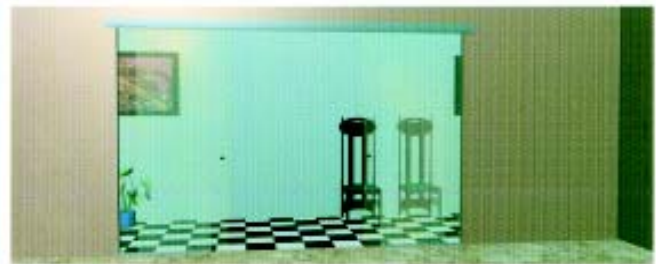
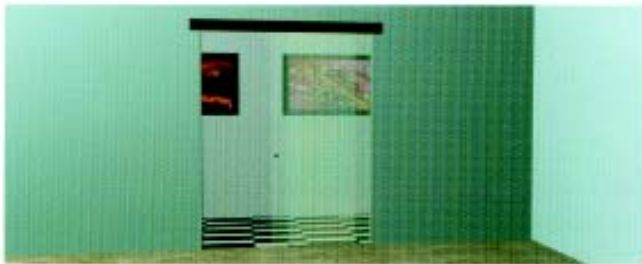

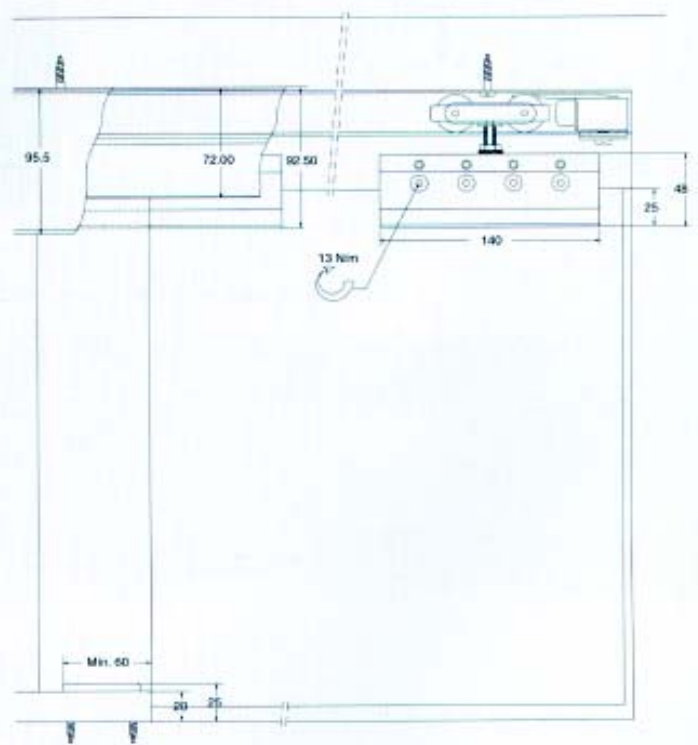
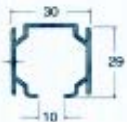
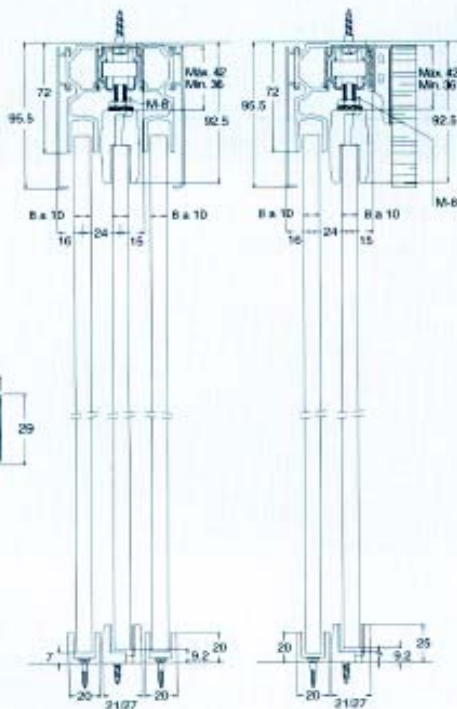

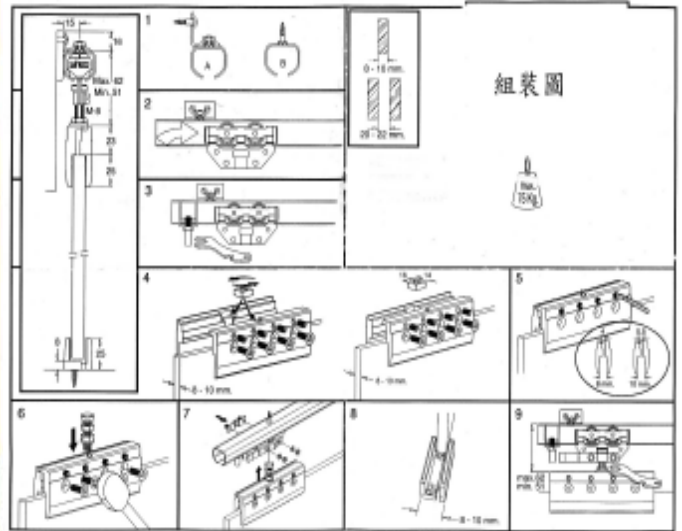

P10030 玻璃懸吊系統 SV-75 公斤毛絲

P10002 玻璃懸吊系統軌道 -2.5M 毛絲



20-22 mm



8-10 mm



29.5x24 mm

SV-75

承載重量：  
75 公斤



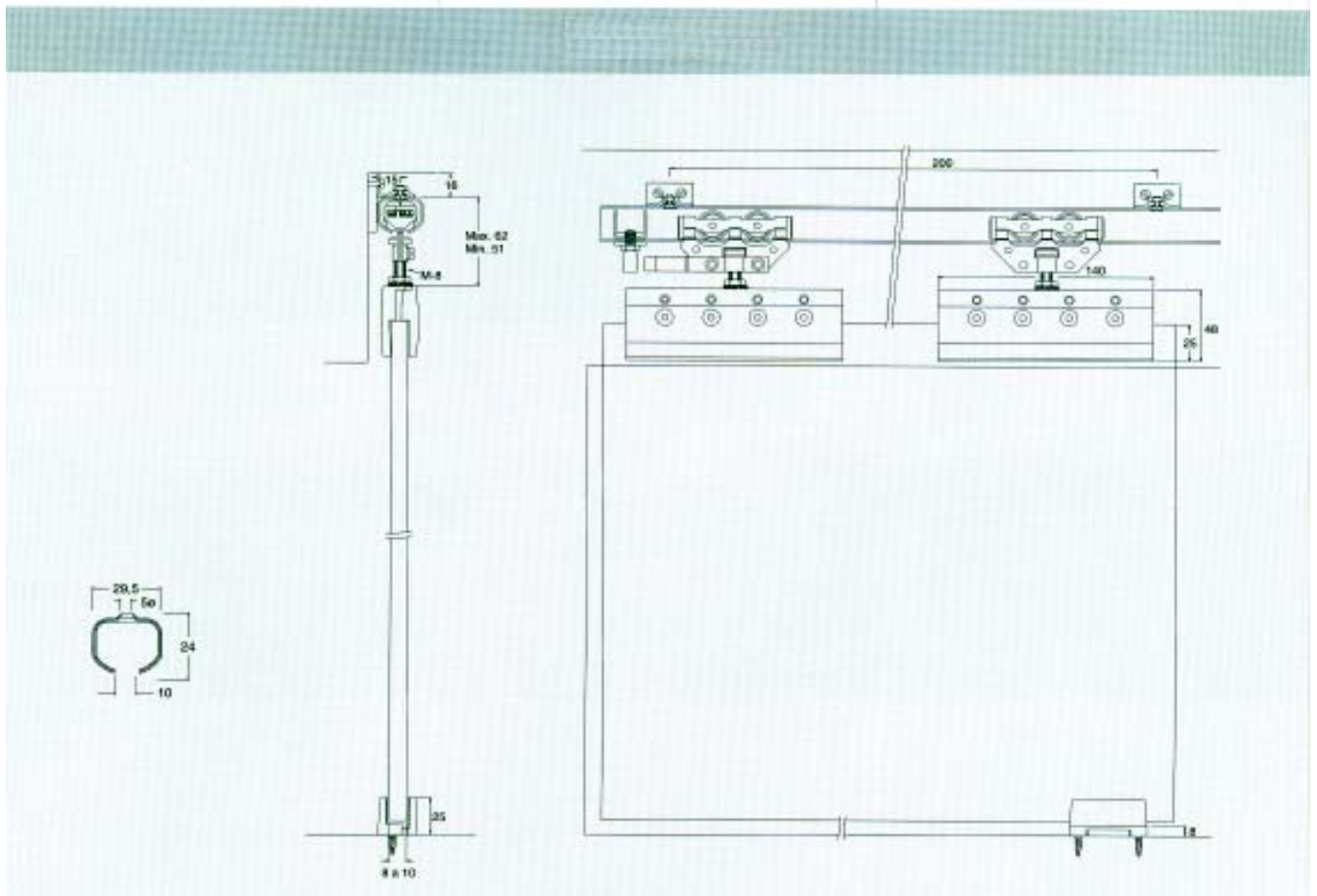



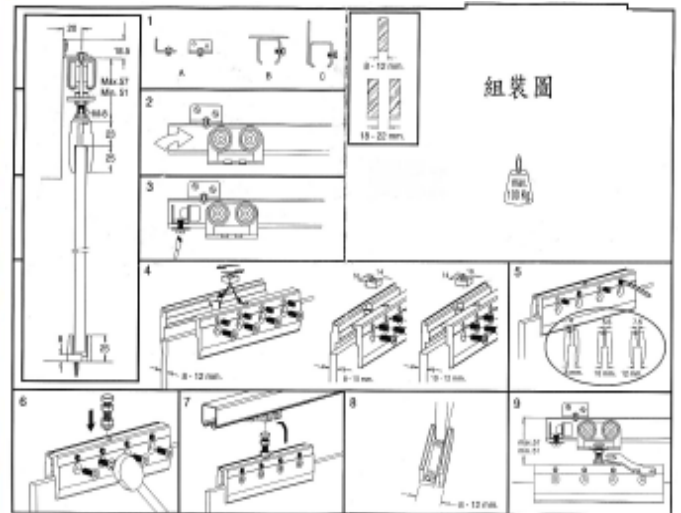
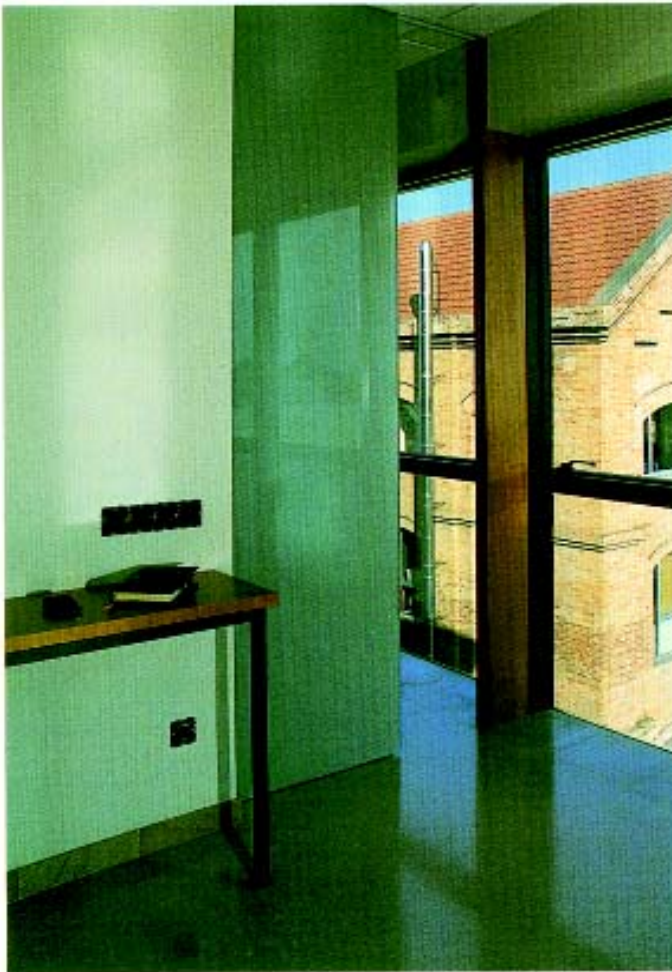

P10040 玻璃懸吊系統 SV-100 公斤銀  
P10000 玻璃懸吊系統軌道 -2.5M 銀



18-22 mm



8-12 mm



30x30 mm

SV-100

承載重量：  
100 公斤

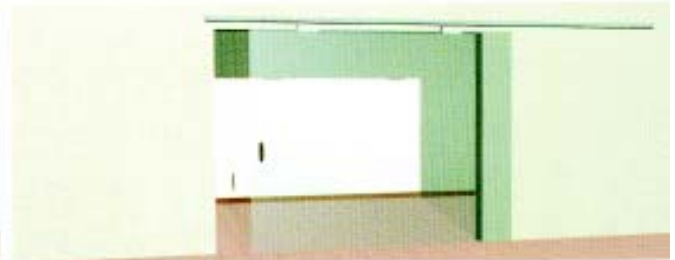

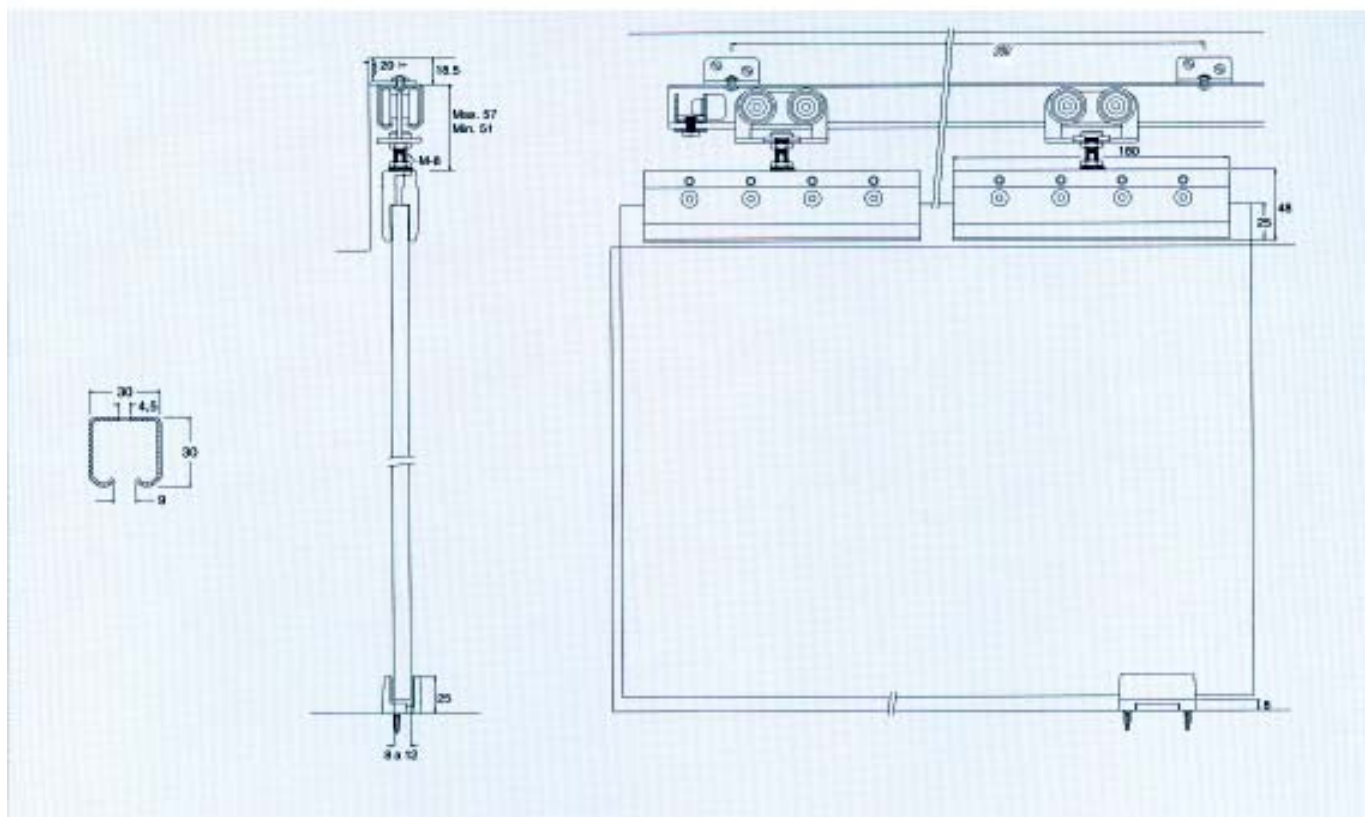
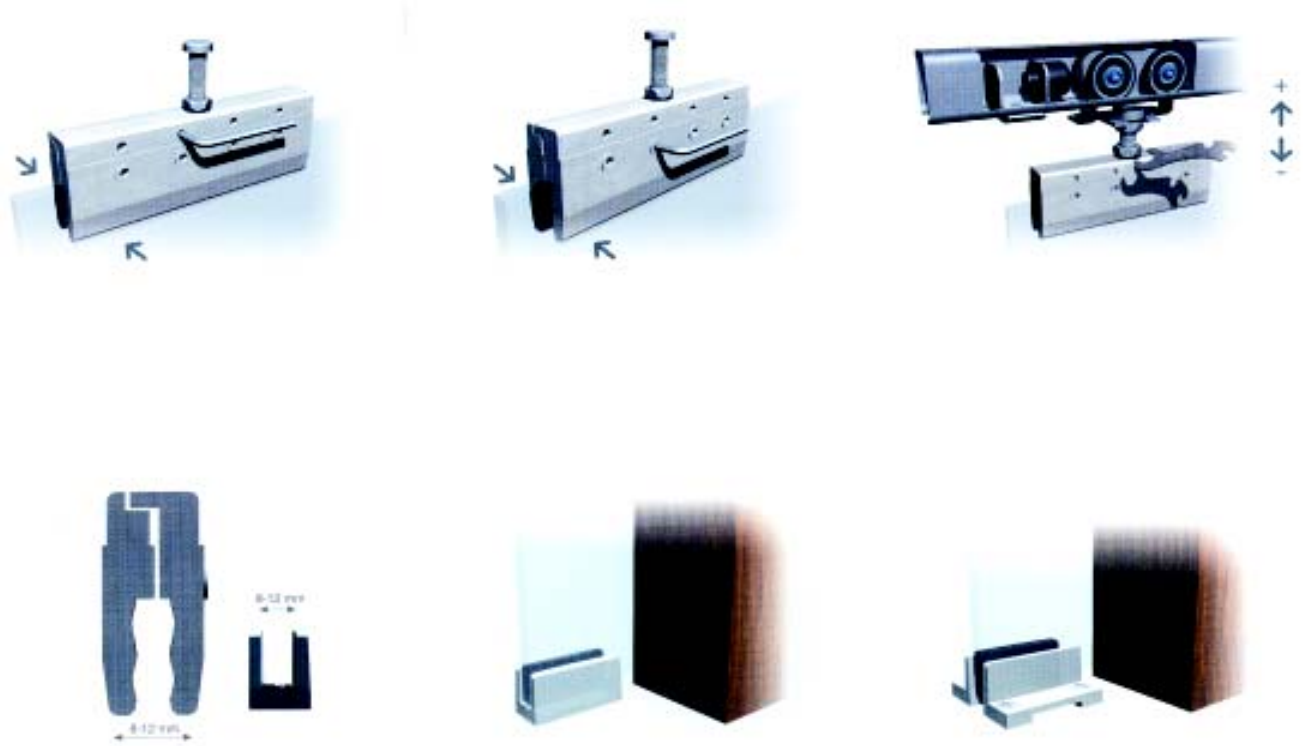



SV-A100

承載重量：100 公斤

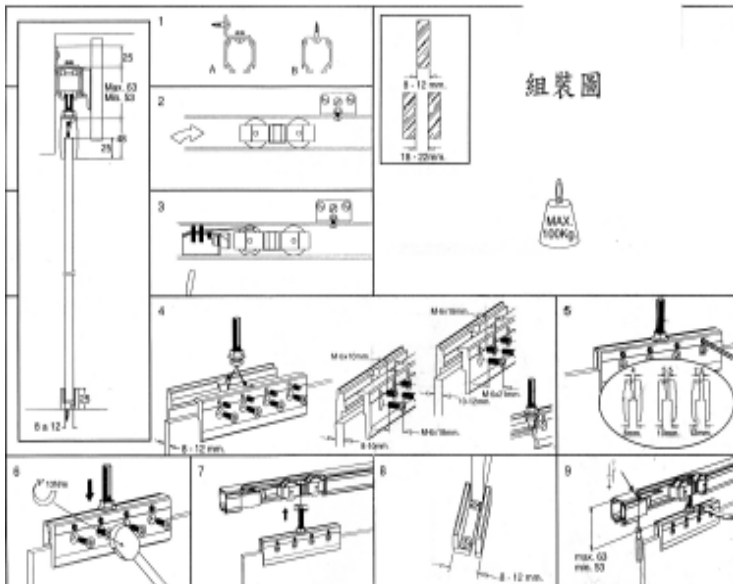

P10140A\* 玻璃懸吊系統 SV-A100 公斤銀  
P10005 玻璃懸吊系統軌道 -3M 116/30 銀

Características técnicas / Technical characteristics / Caractéristiques techniques



26-30 mm



8-12 mm



38x39,5 mm

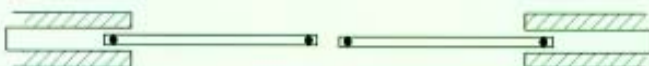

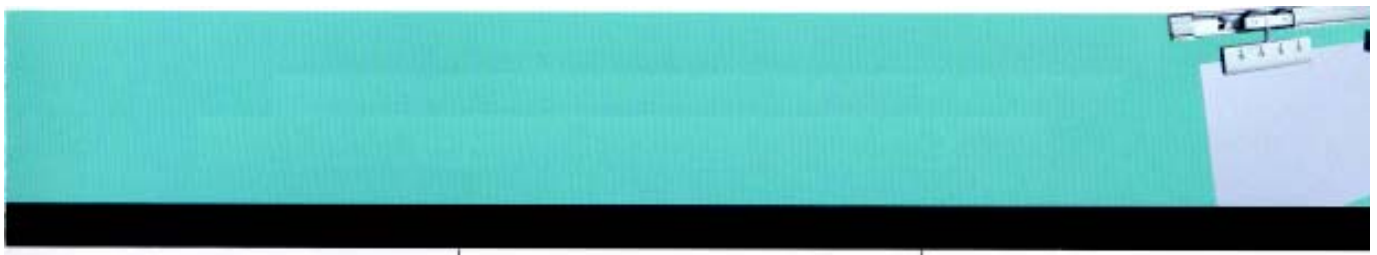

fig. 1



fig. 2



fig. 3

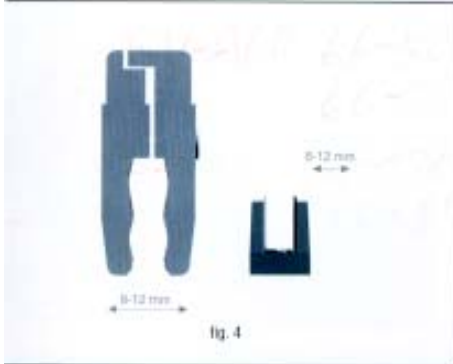
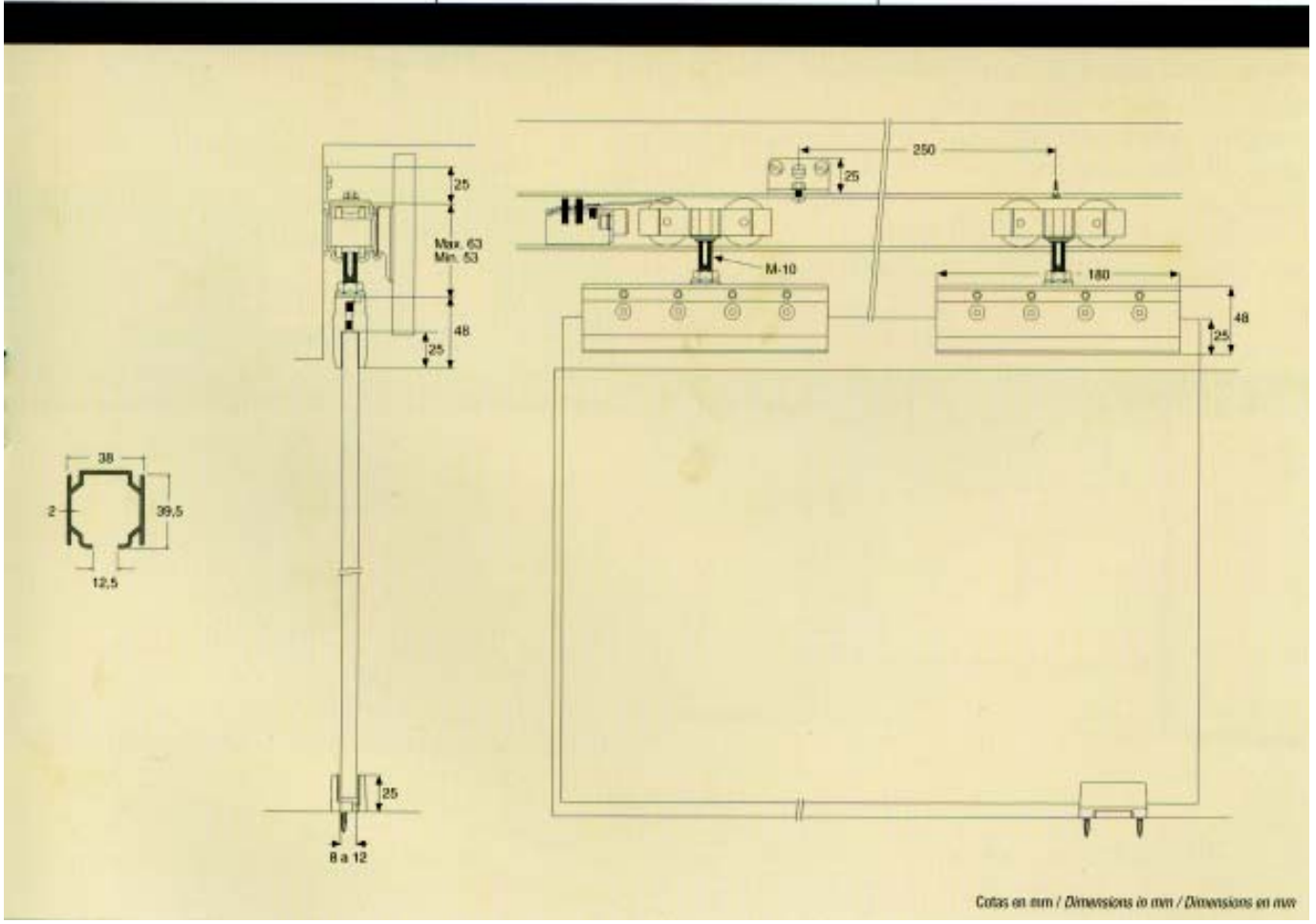

fig. 4





SV-A125

承載重量： 125 公斤

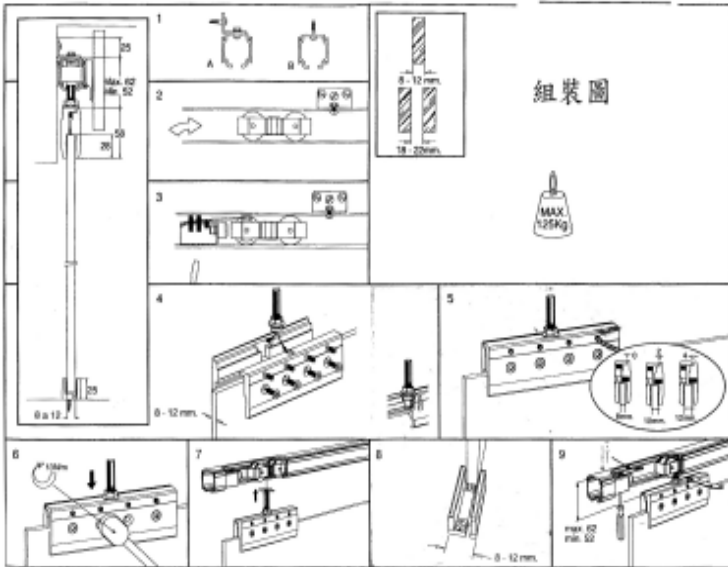

P10145A\* 玻璃懸吊系統 SV-A125 公斤銀  
P10006 玻璃懸吊系統軌道 -3M 126/30 銀



26-30 mm



8-12 mm



38.5x40.5 mm

Variantes de instalación / Installation possibilities / Variantes d'installation

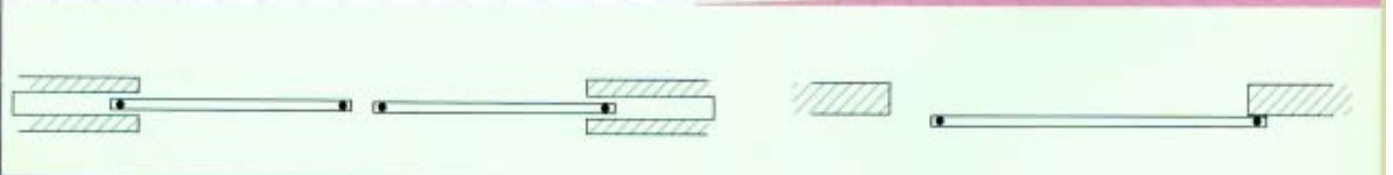

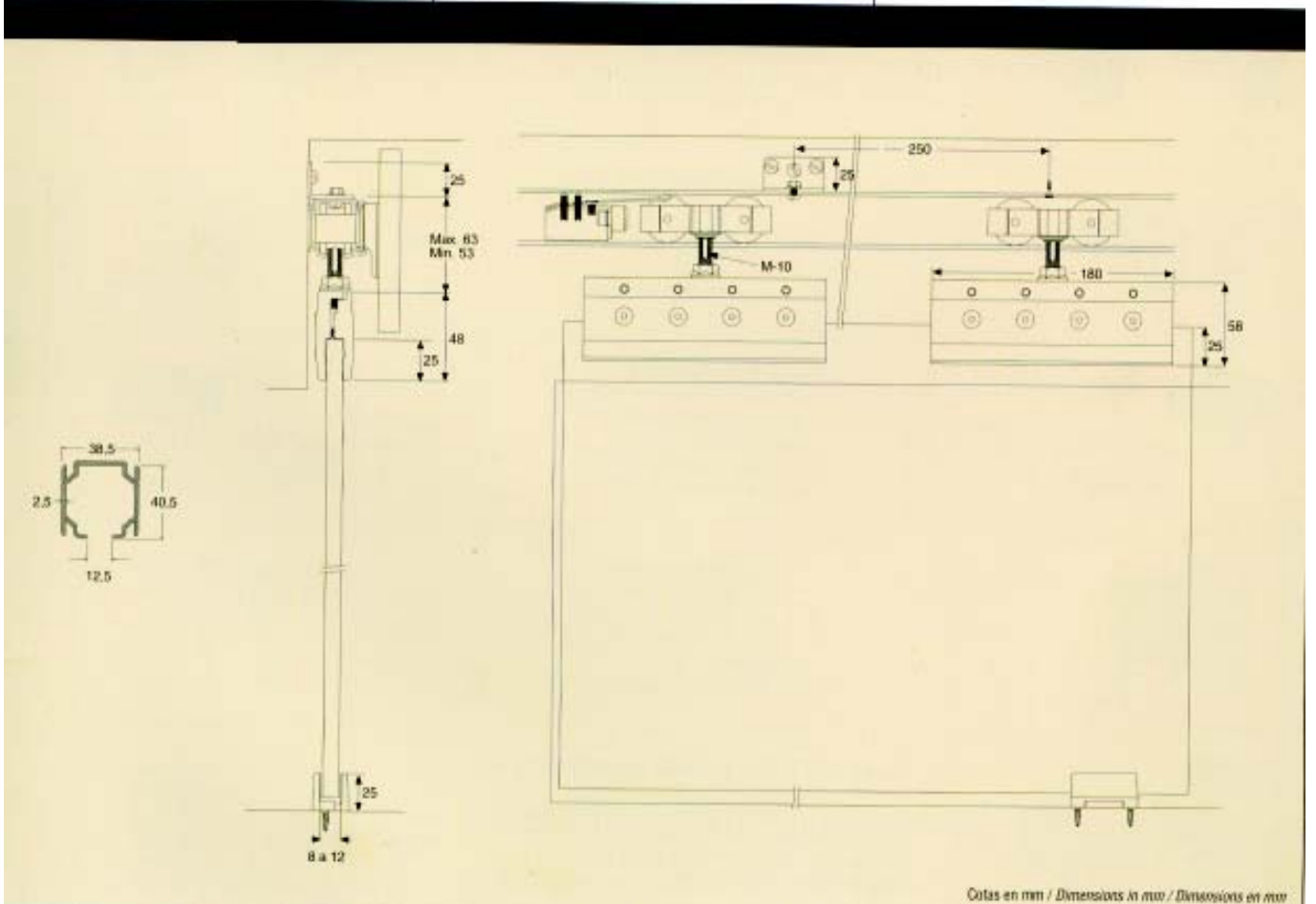
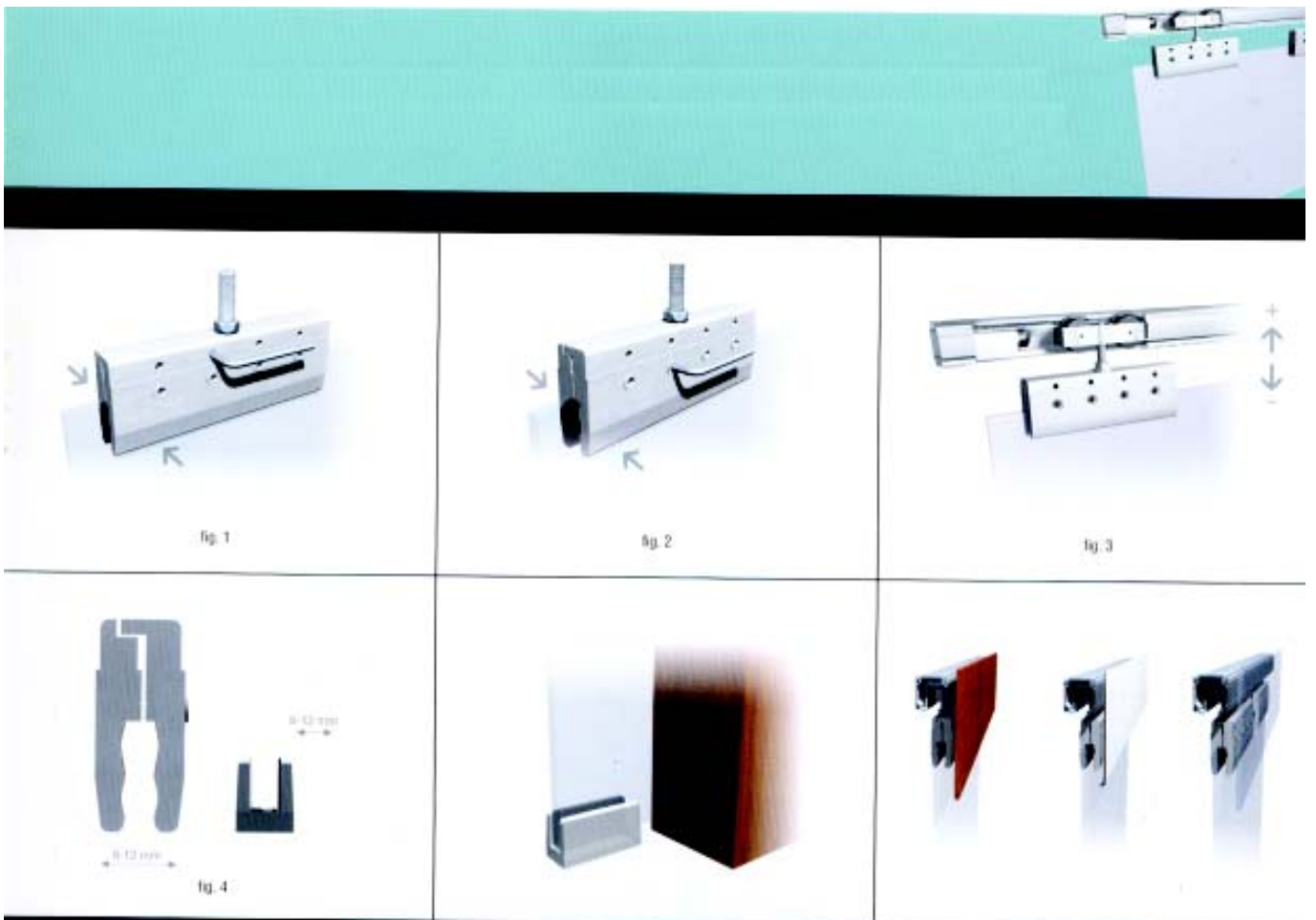



P10220 玻璃折疊門  
系統-EF01/2



P10221 玻璃折疊門  
系統-EF01/4



P10222 玻璃折疊門  
系統-EF02

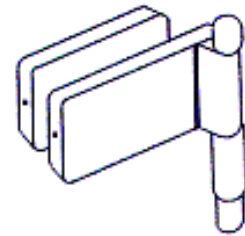
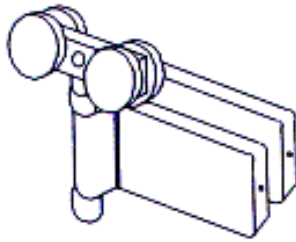
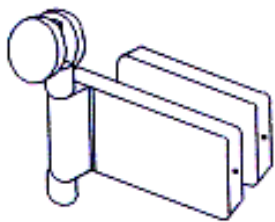

P10230 玻璃折疊門  
系統-EF03



P10240 玻璃折疊門  
系統-EF04



P10250 玻璃折疊門  
系統-EF05=V507

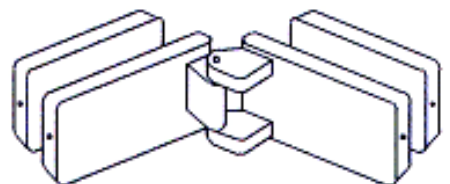
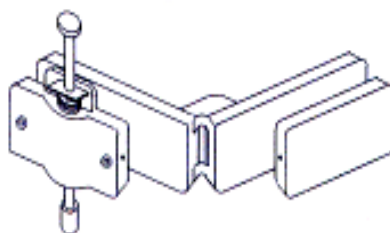
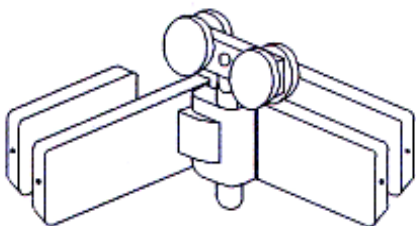

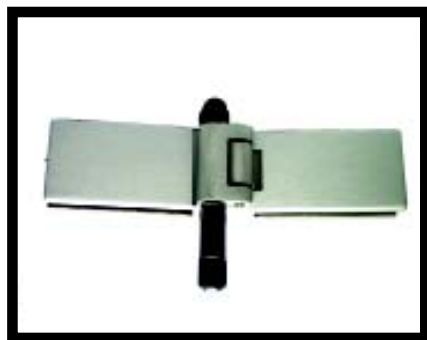

P10260 玻璃折疊門  
系統-EF06



P10270 玻璃折疊門  
系統-EF07



P10280 玻璃折疊門  
系統-EF08

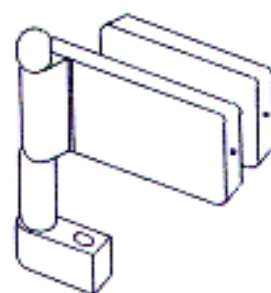
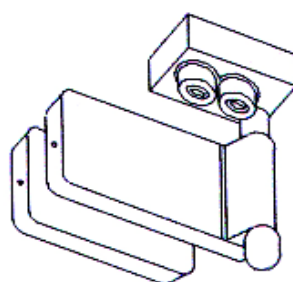
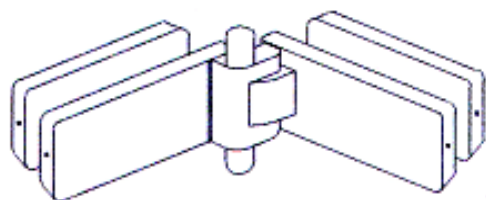

P10290 玻璃折疊門  
系統-EF09



P10300 玻璃折疊  
門鎖-VB94

P10310 玻璃折疊  
門鎖受口-VB95

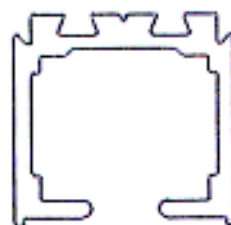
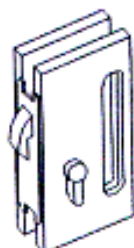
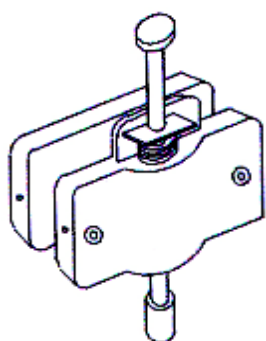

P10210 玻璃折疊門  
上軌道-600 (3M)



P10212 玻璃折疊門  
特殊軌道框架-94T(3M)



P10211 玻璃折疊門  
下軌道-U202020 (3M)



EASYFOLD

2 Panels

P10200\* 玻璃折疊門系統 - 二門

References needed:

EF07	Q=1	EF04	Q=1	EF01	Q=1 2or4 wheels	VB94	Q=1
EF08	Q=1	EF03	Q=0	EF02	Q=1		
V507	Q=1 or 2	EF06	Q=0	EF09	Q=0		

易利折

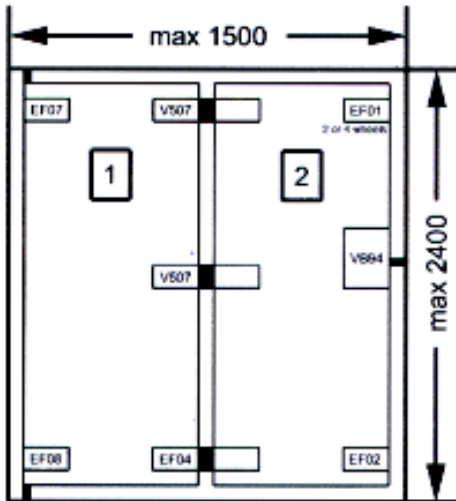

折疊門系統

易利折：一種用於玻璃隔板的可滑動裝置系統，適用於室內室外各種狀況。

使用特製的玻璃鉸鍊固定玻璃隔板並結合掛桿使其能自由滑動於鋁製軌道中。同時在地板上及門檻上預留導槽是必要的。

而該掛桿具有“不銹鋼製的軸承”可方便移動，且無須保養。

裝置後的易利折玻璃隔板具，有特殊設計彈簧式腳控門門鎖的保障。

EASYFOLD

3 Panels

P10201\* 玻璃折疊門系統 - 三門

References needed:

EF07	Q=1	EF04	Q=1	EF01	Q=0 2or4 wheels	VB94	Q=1
EF08	Q=1	EF03	Q=1	EF02	Q=0		
V507	Q=1 or 3	EF06	Q=1	EF09	Q=1		

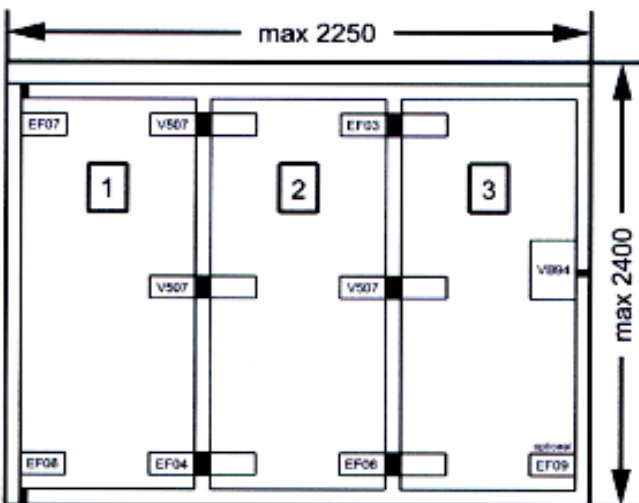

易利折組裝完後之最後一片隔板可使用門門式(1)的鎖鎖住。

滑行的軌道及其他材料配件可以進行表面處理或者電鍍。

技術資料

每片玻璃板最大寬度 750mm

每片玻璃板最大高度 2400mm

每片玻璃板最重 45kg

玻璃厚度

8 或 10mm 可調整玻璃之厚度

**EASYFOLD**

**4 Panels**

P10202\* 玻璃折疊門系統 - 四門

References needed:

EF07	Q=1	EF04	Q=2	EF01	Q=1 2or4 wheels	VB94	Q=1
EF08	Q=1	EF03	Q=1	EF02	Q=1		
V507	Q=2 or 5	EF06	Q=1	EF09	Q=0		

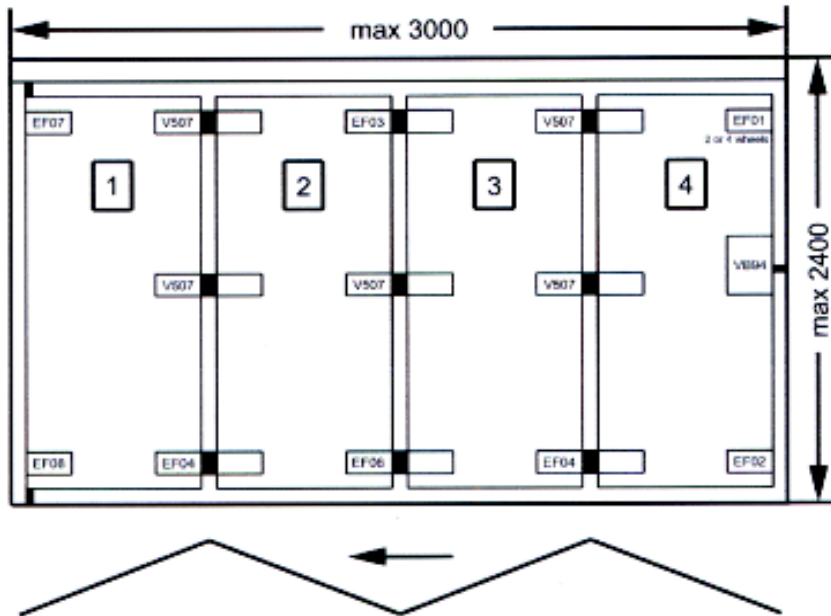

**EASYFOLD**

**5 Panels**

P10203\* 玻璃折疊門系統 - 五門

References needed:

EF07	Q=1	EF04	Q=2	EF01	Q=0 2or4 wheels	VB94	Q=1
EF08	Q=1	EF03	Q=2	EF02	Q=0		
V507	Q=2 or 5	EF06	Q=2	EF09	Q=1		

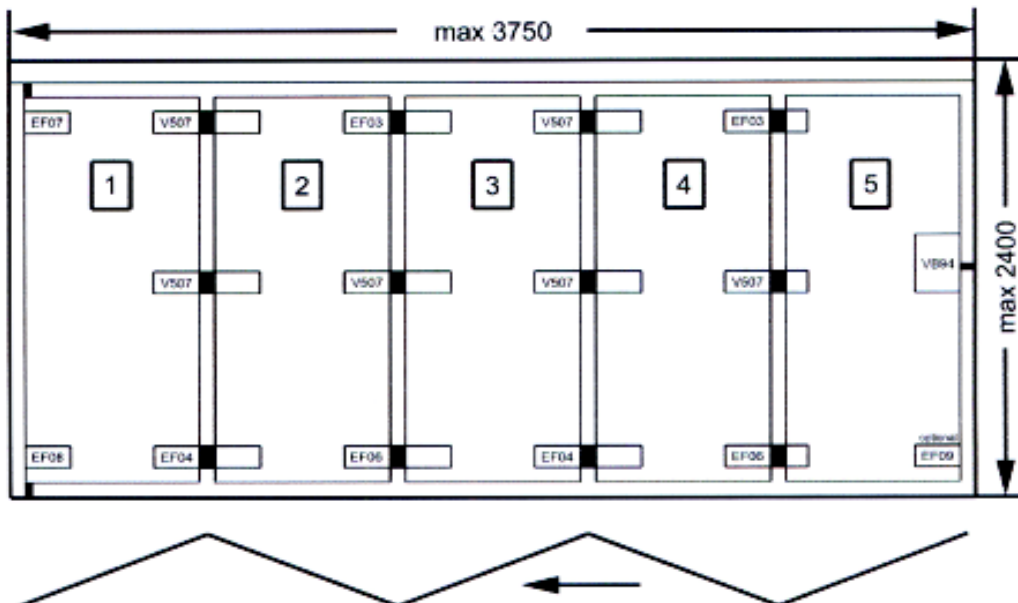



EASYFOLD 6 Panels

P10204\* 玻璃折疊門系統-六門

References needed:

EF07	Q=1	EF04	Q=3	EF01	Q=1 <small>2or4whets</small>	VB94	Q=1
EF08	Q=1	EF03	Q=2	EF02	Q=1		
V507	Q=3 <small>or 8</small>	EF06	Q=2	EF09	Q=0		

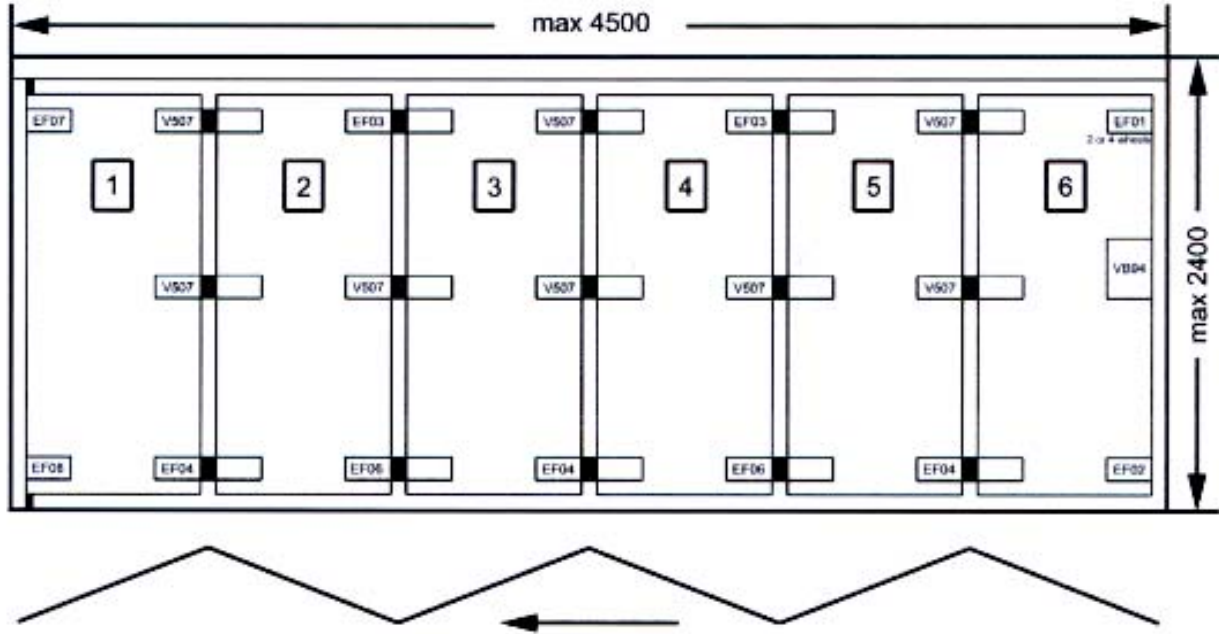

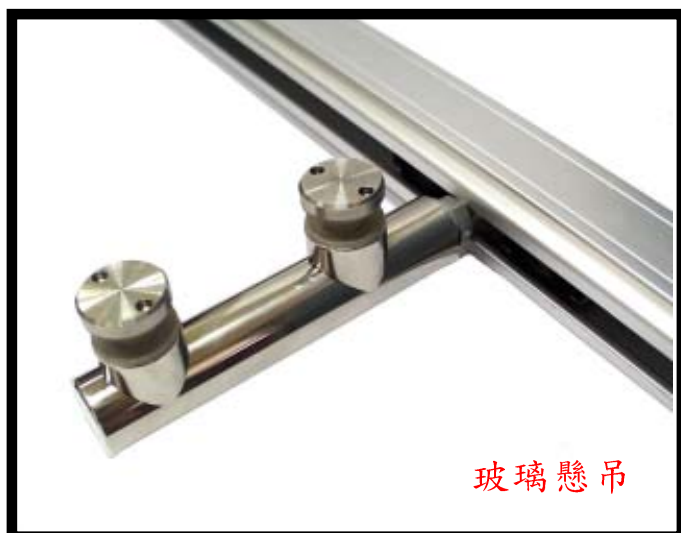

玻璃懸吊

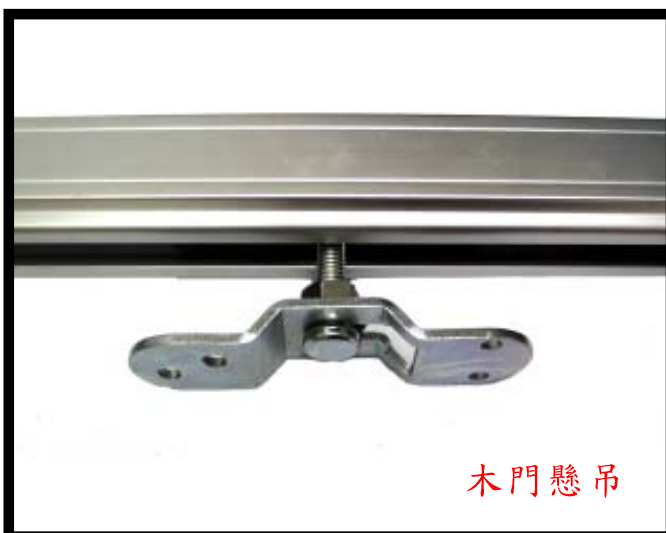

木門懸吊

P10160 不鏽鋼玻璃懸吊系統  
承載 200 公斤(附軌道 250C)

P10161 木門懸吊系統(附軌道 250C)

